

Live Content Producer

Operating Instructions

Software Version 1.10

ANYCAST STATION



AWS-G500

Table of Contents

Usage Notes	9
-------------------	---

Chapter 1 Overview

Features of This System	11
Example Applications	13
Names and Functions of Parts	14
Front Panel.....	14
Rear Panel.....	18
Side Panel	21
Other Parts	22
Operation Screen	23
Menu Operations	27
Operation screen (Text Typing Tool Software)	30

Chapter 2 Preparations

Installation/Default Settings	37
Installing the Unit	37
Fitting a Keyboard	38
Starting and Closing Down the Unit	40
Selecting the Keyboard Language.....	42
Setting the Time Zone	42
Setting the Date and Time	43
Adjusting the Display Brightness.....	43
Selecting the Video Output Signal Format.....	44
Connections	45
Connecting a Camera with VISCA Support.....	46
Connecting a Microphone	46
Connecting a Computer (RGB Input).....	47
Connecting a Camcorder	47
Connecting a VCR.....	48
Connecting an External Hard Disk.....	48
Connecting a Plasma Display/Projector	49
Connecting an Amplifier	50
Preventing Accidental Cable Disconnection	50
Installing Option Boards.....	51
Settings Related to Input Signals	52
Relation Between Input Signals and System Components...	52
Video Signal Related Settings	53
Audio Signal Related Settings.....	54
Relation Between Program Output Display and Input and Output Formats	57

Chapter 3 Operations

Video Switching	59
Basic Basics of Video Switching	59
Basic Changing the Video with a Cut	60
Basic Changing the Video with a Effect Transition.....	62
Changing the Transition Time.....	66
Changing the Effect Pattern.....	67
Using Fade-to-Black (FTB).....	67
Using Color Bars and Color Mattes	68
Basic Using the Downstream Key (DSK) Function to Add Text or an Image	69
Showing a Logo on the Screen.....	72
Using Luminance Keying.....	74
Previewing Keying Results (effect preview).....	76
Adjusting the Combined Video	78
Cropping Unwanted Portions From the Video Being Combined.....	79
Applying Edge Effects	79
Creating a Title Graphic with the Text Typing Tool	81
Features of the Text Typing Tool Software	81
Flow of Operations	82
Starting Up.....	84
Closing Down.....	85
Standard Operations	85
File Operations	88
Working on Text Objects	95
Working on Line Objects	101
Shadow Operations.....	104
Background Color Operations (Creating Telop and Flip)..	106
Color Operations	108
Object Layout	113
Adding and Deleting Sheets	115
Simulating the Keing Effects.....	116
Key Combination in the Anycast Station Main Software ..	118
Importing a Font File.....	119
Controlling Cameras	121
Registering Cameras to be Controlled.....	121
Controlling Camera Manually.....	122
Storing a Camera Preset	123
Setting the Camera Control	126
Resetting the Camera.....	127
About Camera Tallies.....	128
Audio Mixing	129
Recording Video and Audio on an External Device	130
Recording Program Output on a VCR.....	130
Recording Inputs on an External Hard Disk.....	131
Operations on Files on the External Hard Disk.....	134
Disconnecting the External Hard Disk.....	137

Recovering an External Hard Disk.....	138
Using a Computer to Play Files Recorded on an External Hard Disk	139
Using the Intercom Function	140
Connecting the Intercom System.....	140
Speaking on the Intercom System	141
Monitoring Audio	142
Determining the Audio Signal Output Destinations.....	142
Displaying the Audio Signal Output Destinations	143
Monitoring Output Audio.....	144
Monitoring the Audio of a Particular Channel Only	145
Video/Audio Signal Adjustments and Settings	146
Adjusting Analog Video Input Signals.....	146
Adjusting the Clock Phase of RGB Signals	147
Adjusting Color Matte.....	147
Applying an Offset to the Program Output Video.....	147
Setting the RGB Output Signal Format.....	148
Applying Filters to the Program Output Video	149
Adjusting the Audio Input Signal Levels	149
Cutting High Frequency or Low Frequency.....	150
Adjusting the Equalizer	150
Using the Limiter or Compressor	151
Adjusting the Audio Left and Right Channel Balance	152
Adjusting the Output Levels for Each Destination.....	152
If the Output Video Is Delayed with Respect to the Audio	153
Adjusting the Output Using the Oscillator Signal	154
Importing and Deleting Files	156
Importable Files.....	156
Importing Graphics Files	156
Importing Logo Files	157
Deleting Files.....	158
Checking the Internal Hard Disk Remaining Capacity	159
Formatting an External Hard Disk	160
Formatting a “Memory Stick”	162
Formatting a USB Flash Memory	164
Streaming	166
What Is Streaming?	166
Configuring the Network Settings.....	166
Setting Live Streaming Transmission	169
Starting and Stopping Streaming.....	171
Settings Required for Viewing Streaming.....	171
Placing Streaming Links in a Web Site	172

Chapter 4 Appendix

Maintenance	175
Checking the Operating Software Version.....	175
Upgrading the Operating Software.....	176
Messages	179
Message Structure	179
List of Messages	181
Troubleshooting	186
“Memory Stick” Media	189
Notes on using “Memory Stick” media.....	189
About data.....	189
Notes on using “Memory Stick Duo”	189
Notes on using the Memory Select function.....	189
Specifications	190
Dimensions	193
Glossary	194
Index	197

Owner's Record

The model and serial numbers are located at the bottom.

Record these numbers in the spaces provided below. Refer to them whenever you call upon your Sony dealer regarding this product.

Model No. _____ Serial No. _____

WARNING

To prevent fire or shock hazard, do not expose the unit to rain or moisture.

To avoid electrical shock, do not open the cabinet. Refer servicing to qualified personnel only.

THIS APPARATUS MUST BE EARTHED.

WARNUNG

Um Feuergefahr und die Gefahr eines elektrischen Schlages zu vermeiden, darf das Gerät weder Regen noch Feuchtigkeit ausgesetzt werden.

Um einen elektrischen Schlag zu vermeiden, darf das Gehäuse nicht geöffnet werden. Überlassen Sie Wartungsarbeiten stets nur qualifiziertem Fachpersonal.

DIESES GERÄT MUSS GEERDET WERDEN.

AVERTISSEMENT

Afin d'éviter tout risque d'incendie ou d'électrocution, ne pas exposer cet appareil à la pluie ou à l'humidité.

Afin d'écarter tout risque d'électrocution, garder le coffret

fermé. Ne confier l'entretien de l'appareil qu'à un personnel qualifié.

CET APPAREIL DOIT ÊTRE RELIÉ À LA TERRE.

WARNING

This unit has no power switch.

When installing the unit, incorporate a readily accessible disconnect device in the fixed wiring, or connect the power cord to a socket-outlet which must be provided near the unit and easily accessible.

If a fault should occur during operation of the unit, operate the disconnect device to which the power supply off, or disconnect the power cords.

WARNUNG

Dieses Gerät hat keinen Netzschalter.

Beim Einbau des Geräts ist daher im Festkabel ein leicht zugänglicher Unterbrecher einzufügen, oder das Netzkabel muß mit einer in der Nähe des Geräts befindlichen, leicht zugänglichen Wandsieckdose verbunden werden.

Wenn während des Betriebs eine

Funktionsstörung auftritt, ist der Unterbrecher zu betätigen bzw. das Netzkabel abzuziehen, damit die Stromversorgung zum Gerät unterbrochen wird.

AVERTISSEMENT

Cet appareil ne possède pas d'interrupteur d'alimentation.

Lors de l'installation de l'appareil, incorporer un dispositif de coupe dans le cablage fixe ou brancher le cordon d'alimentation dans une prise murale proche de l'appareil et facilement accessible.

En cas de problème lors du fonctionnement de l'appareil, enclencher le dispositif de coupe d'alimentation ou débrancher le cordon de la prise.

WARNING: THIS WARNING IS APPLICABLE FOR USA ONLY.

If used in USA, use the UL LISTED power cord specified below.

DO NOT USE ANY OTHER POWER CORD.

Plug Cap Parallel blade with ground pin
(NEMA 5-15P Configuration)

Cord Type SJT, three 16 or 18 AWG wires

Length	Minimum 1.5 m, Less than 2.5 m (8 ft 3 in)
Rating	Minimum 10 A, 125 V

Using this unit at a voltage other than 120 V may require the use of a different line cord or attachment plug, or both. To reduce the risk of fire or electric shock, refer servicing to qualified service personnel.

WARNING: THIS WARNING IS APPLICABLE FOR OTHER COUNTRIES.

1. Use the approved Power Cord (3-core mains lead) / Appliance Connector / Plug with earthing-contacts that conforms to the safety regulations of each country if applicable.
2. Use the Power Cord (3-core mains lead) / Appliance Connector / Plug conforming to the proper ratings (Voltage, Ampere).

If you have questions on the use of the above Power Cord / Appliance Connector / Plug, please consult a qualified service personnel.

AVERTISSEMENT:

1. Utiliser un cordon d'alimentation approuvé (conducteur d'alimentation 3 âmes)/ connecteur d'appareil/prise avec contacts de mise à la terre conforme aux règles de sécurité de chaque pays si applicable.
2. Utiliser un cordon d'alimentation approuvé (conducteur d'alimentation 3 âmes)/ connecteur d'appareil/prise conforme aux valeurs nominales (tension, ampérage) correctes.

S'adresser à un personnel de service qualifié pour toute question concernant l'emploi du cordon d'alimentation/connecteur d'appareil/prise cidessus.

WARNUNG:

1. Verwenden Sie Netzkabel(dreiadrig), Geräteanschlüsse und Netzkabelstecker mit Masseleitung, die den Sicherheitsrichtlinien des jeweiligen Landes entspricht.
2. Verwenden Sie Netzkabel (dreiadrig), Geräteanschlüsse und Netzkabelstecker mit Masseleitung, die den vor Ort herrschenden Spannungsanforderungen (Spannung, Stromstärke) entsprechen.

Bei Frage über die Eignung und Sicherheit von Netzkabeln (dreiadrig), Geräteanschlüssen und Netzkabelsteckern wenden Sie sich bitte an einen qualifizierten Electrotechniker.

For the customers in the USA

This equipment has been tested and found to comply with the limits for a Class A digital device, pursuant to Part 15 of the FCC Rules. These limits are designed to provide reasonable protection against harmful interference when the equipment is operated in a commercial environment. This equipment generates, uses, and can radiate radio frequency energy and, if not installed and used in accordance with the instruction manual, may cause harmful interference to radio communications. Operation of this equipment in a residential area is likely to cause harmful interference in which case the user will be required to correct the interference at his own expense.

You are cautioned that any changes or modifications not expressly approved in this manual could void your authority to operate this equipment.

The shielded interface cable recommended in this manual must be used with this equipment in order to comply with the limits for a digital device pursuant to Subpart B of Part 15 of FCC Rules.

IMPORTANT

The nameplate is located on the bottom

CAUTION

Danger of explosion if battery is incorrectly replaced.
Replace only with the same or equivalent type recommended by the manufacturer.
Dispose of used batteries according to the manufacturer's instructions.

IMPORTANT

La plaque signalétique se situe sous l'appareil.

ATTENTION

Risque d'explosion si la batterie n'est pas remplacée correctement.
Utilisez uniquement le même type de batterie ou une batterie équivalente recommandée par le fabricant.
Jetez les batteries usagées selon les instructions du fabricant.

WICHTIG

Das Namensschild befindet sich auf der Unterseite des Gerätes.

VORSICHT

Explosionsgefahr bei Verwendung falscher Batterien.

Batterien nur durch den vom Hersteller empfohlenen oder einen gleichwertigen Typ ersetzen.

Verbrauchte Batterien entsprechend den Anweisungen des Herstellers entsorgen.

For the customers in Europe

WARNING

This is a Class A product. In a domestic environment, this product may cause radio interference in which case the user may be required to take adequate measures.

Pour les utilisateurs en Europe

AVERTISSEMENT

Il s'agit d'un produit de Classe A. Dans un environnement domestique, cet appareil peut provoquer des interférences radio, dans ce cas l'utilisateur peut être amené à prendre des mesures appropriées.

Für Kunden in Europa

Warnung

Dies ist eine Einrichtung, welche die Funk-Entstörung nach Klasse A besitzt. Diese Einrichtung kann im Wohnbereich Funkstörungen verursachen; in diesem Fall kann vom Betreiber verlangt werden, angemessene Maßnahmen durchzuführen und dafür anzukommen.

Für Kunden in Deutschland

Dieses Gerät ist nur für den Gebrauch in Gewerbe und Leichtindustrie bestimmt.

For Customers in Taiwan only



廢電池請回收

Usage Notes

Copyright

Using this unit for video and/or audio switching, or distribution over the Internet or otherwise may in some cases require the permission of the copyright holder of the video or audio.

To protect copyright, observe the following points carefully when using this unit.

- When connecting a recording device to this and recording video or audio, carefully observe laws relating to copyright.
- Without the permission of the copyright holder, the showing or distribution of video or audio material of which the copyright is held by a third party, or the act of recording on the hard disk of this unit, sharing folders, and permitting of access to a private group or to the public is prohibited by law.
- Even with the right to show or distribute, the act of using this unit to edit original content with wipes or dissolves, for example, may be prohibited by law.
- With a software upgrade or functional extension, with the object of protecting copyright, the specifications for the video and audio signals that can be input may be changed without notice.

Points to check before using devices

- When recording or streaming valuable data, be sure to check the device connections beforehand, or carry out a streaming test, to make sure that the system is operating normally.
- If when using a camera or videocassette recorder, tape or similar there should be a failure in another device preventing recording, no responsibility can be taken for any loss of the material which was to have been recorded.
- Under copyright law, you may not use recorded video or audio other than for your personal enjoyment without the permission of the copyright holder. Note that at live performances, shows and exhibitions, even for your personal entertainment shooting may be restricted.

Regarding cables

Use cables (particularly generic RGB) which are as short as possible.

IEEE1394 (i.LINK) cables

Use cables with enhanced shielding, ferrite cores, and similar noise-reduction measures.

About the LCD Display

- Do not wipe the surface of the LCD display with a wet object. Water that gets inside the unit may cause it to malfunction.
- Do not set or drop objects on the LCD display. Also, do not put pressure on the display, such as by leaning on it with your hand or elbow.
- Condensation may form on the LCD display when the unit is moved from a cold place to a warm place, such as from the outdoors to room temperature. If condensation forms, thoroughly wipe off any moisture before using the unit. We recommend using tissues to wipe up any condensed moisture. If you wipe up the condensed moisture while the LCD display is still cold, the condensation may form again. Therefore it is best to wait until the LCD display has warmed up to room temperature.
- The LCD display is made with extremely high precision technology. Nonetheless, in some cases black dots may appear, and red, green, and blue dots may not disappear. In addition, depending on the angle the LCD display is viewed from, you may see stripes of irregular color or brightness. This is due to the construction of the LCD display and is not a malfunction.

External Hard disk

- The hard disk is vulnerable to vibration and shock. Be sure to install the hard disk in the best possible environment, following the operating instructions supplied with the drive.
- Even using the recommended hard disk, depending on the operating environment or conditions, or in the event of deterioration because of age, the full performance of the hard disk may not always be obtained.
- Even when using the recommended hard disk to store material, the characteristics of the hard

disk mean that frame drop or other problems may occur.

- To connect the recommended hard disk to this unit, use the interface cable supplied with the recommended hard disk.

Ensuring Good Performance From This Unit

Operation and Storage

Avoid using or storing the unit in the following places.

- Where it is subject to extremes of cold or heat (operating temperature 0°C to 40°C (32°F to 104°F))
- Where it is subject to direct sunlight for extended periods, or close to heating equipment (Note that the temperature inside a car with the windows closed on a summer day can exceed 50°C (122°F))
- In conditions of high humidity or much dust
- Where it is subject to severe vibration
- Close to a source of strong magnetic fields
- Close to a radio, television, or other source of powerful electromagnetic radiation

Install in a level place

This unit is designed to be operated in a level place. Do not turn it vertically, or incline at an angle of 20 degrees or more.

Do not apply strong shocks

Dropping the unit, or subjecting it to other strong shocks may cause it to break.

Do not obstruct the ventilation holes

To prevent the temperature from rising, do not, for example, wrap the unit in a blanket while operating.

Care of the unit

Clean dirt from the cabinet and panel by wiping gently with a dry cloth. If the unit is very dirty, wipe with a cloth steeped in a little neutral detergent, then wipe dry. Do not use alcohol, thinners, insecticides, or other volatile solvents, as this may cause the case to deform or damage the finish.

Shipping

Pack in the original carton, or similar packaging, to cushion the unit from violent shocks.

Features of This System

The Anycast Station Live Content Producer AWS-G500 is an audiovisual production system including camera control, video switching, and a live distribution system for the Internet. The following are the principal features.

All-in-One

AWS-G500 is light and conveniently portable, while combining video switching and audio mixing functions with video monitor and camera control, to provide an inclusive package for live content generation. Whereas previously it was necessary to assemble various devices, this is no longer necessary, and the time and effort required to install, connect, and adjust the equipment has been greatly reduced.

Video Switching

- You can switch among up to six video inputs: analog, DV, or RGB.
- The system provides both mix (dissolve) and wipe transition effects, and luminance keying functions.
- Before carrying out a switching operation, you can preview the next selected image in the PVW viewer.
- You can mix video using a maximum of five effects at one time, such as incorporating (keying) a separate video clip when switching between two video clips with a wipe or other transition effect, as well as superimposing text (downstream key) and displaying a copyright logo.

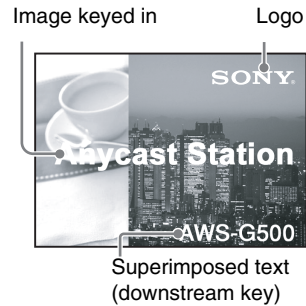

Text Typing Tool Software

The system includes installed text typing tool software, which allows easy creation of titles. Titles created with the text typing tool software can be used in the DSK (downstream key) or as luminance keys.

Audio Mixing

You can mix up to six audio inputs. Each channel is provided with a range of functions, including fader, input trim, filter equalizer, limiter, and compressor pan (balance), allowing the sound quality and level to be adjusted on each channel separately. In addition, each channel has a prefader listen function, allowing you to monitor the input audio before any effects are applied by the fader, and each output has a delay function to correct any discrepancies between the audio and video timing.

Remote Camera Control

- Using a camera with VISCA support, you can remotely control the camera movements, including panning, tilting, and zoom.
- The camera preset function allows you to store camera pan, tilt, and zoom settings. Using the camera preset function, you can immediately set the camera to the preset state when required just by pressing a button.

External Recording Material on an External Hard Disk

You can record video material (video and audio) from this unit, using the recommended hard disk with an i.LINK connection. By connecting the hard disk containing the recorded material to a nonlinear editing system, you can go straight into editing operations, without the need to transfer data from video tape to the nonlinear editing system.

This system can use two hard disks as standard, or three with the addition of an option board, recording four channels (maximum six channels) simultaneously.

Streaming Broadcast

You can encode in Real Media streaming file format (.rm) in real time, for a live broadcast.

* Functions Added in Version 1.1 of the Anycast Station Main Software

Support for USB flash memory

You can use USB flash memory for importing and exporting graphics files, and for importing fonts and software installing.

Support for "Memory Stick Pro"

You can use a "Memory Stick Pro." The parallel data transfer function (high-speed data transfer) is not supported, however.

External hard disk support

You can record input material on an external hard disk connected to the i.LINK connector.

You can also play files recorded on the external hard disk as input source material.

Camera tally support

With a camera with VISCA support and tally support (BRC-300 and similar), you can use the camera tally function.

Support for key wipe transitions

You can use a wipe transition when keying.

Effect preview

You can check the result of keying before using it for program output.

DV recording of program output

You can record program output in DV format on a VCR connected to the DV connector.

Example Applications

The following are examples of applications utilizing the functions of AWS-G500.

Event and presentation support

At seminars, events, and presentations you can use this unit to switch among camera inputs and data from a computer, while displaying the output on a projector or large monitor.

Principal functions used: video switching (such as cut switching), audio mixing, RGB input/output

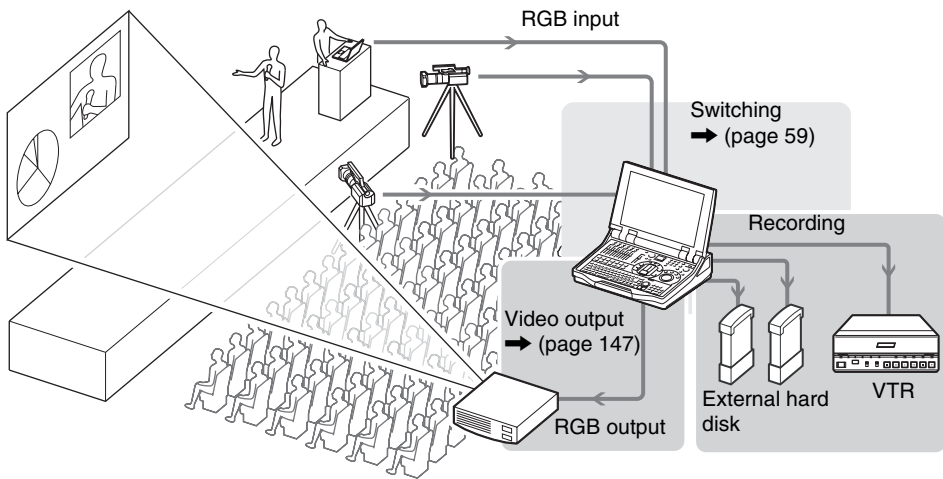

Simple Internet live broadcast

This unit includes a streaming server function. For broadcast to small audiences (about 20 people) over an intranet, this unit can be used as the streaming server without requiring an external server.

Principal functions used: video switching (such as a wipe transition), audio mixing, streaming encode, streaming server

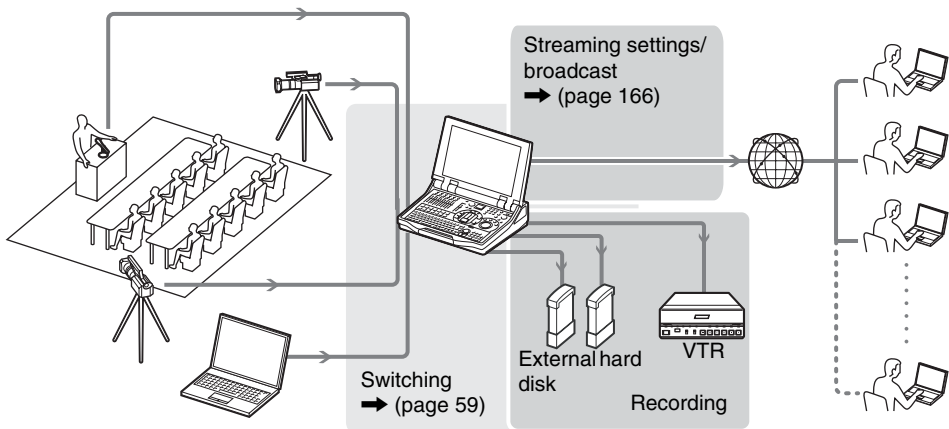

Names and Functions of Parts

Front Panel

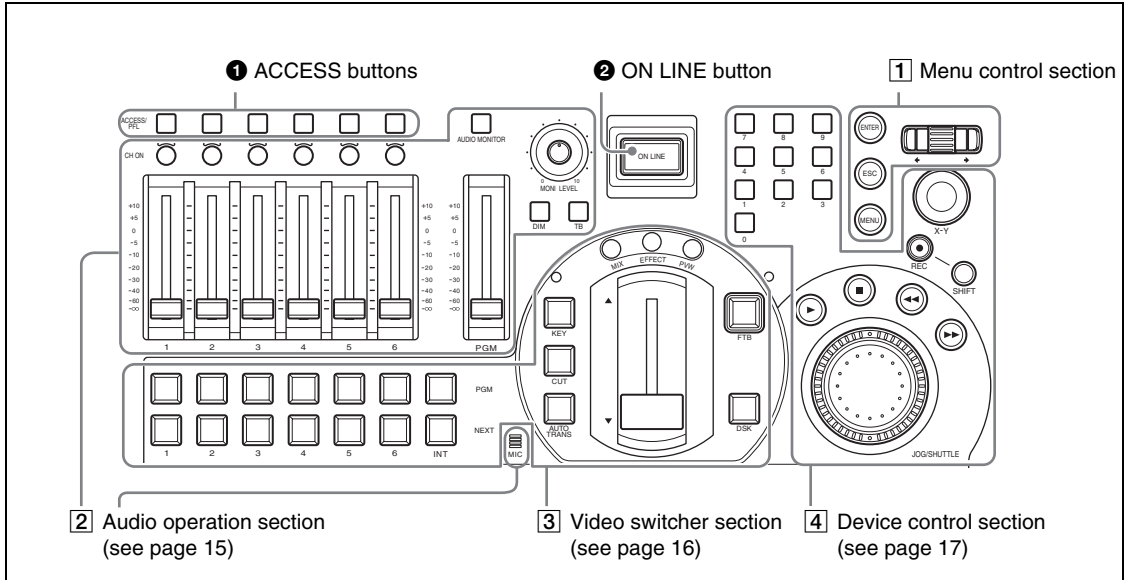

1 ACCESS buttons

These buttons display the ACCESS menu (page 27), and for audio monitoring (page 145). When you press an ACCESS button in one of columns 1 to 6, the ACCESS menu appears allowing adjustment of the related video and audio settings. If you hold down the ACCESS button in one of columns 1 to 6 for 0.5 seconds or more, you can monitor the audio assigned to the channel fader in the same column, and display the audio level meter for that channel only.

By holding down two or more ACCESS buttons simultaneously, you can monitor multiple audio channels.

2 ON LINE button

This button starts and stops streaming distribution (page 171).

1 Menu control block

Use these controls to access the menus and settings.

For details of operations refer to “Menu Operations” (page 27).

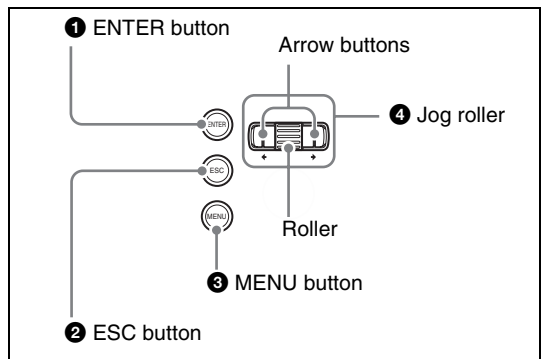

1 ENTER button

This button confirms an item or input value in menu operations.

2 ESC button

This button closes the current menu. In alphanumeric input mode, it cancels, and returns one level up the menu tree.



3 MENU button

This toggles the top menu on or off.

4 Jog roller

Turn the roller up and down to select a menu item. Pressing the roller like a button has the same effect as pressing the ENTER button. Use the arrow buttons when a menu operation requires movement to left or right.

2 Audio operation section

Use these controls for audio settings and operations.

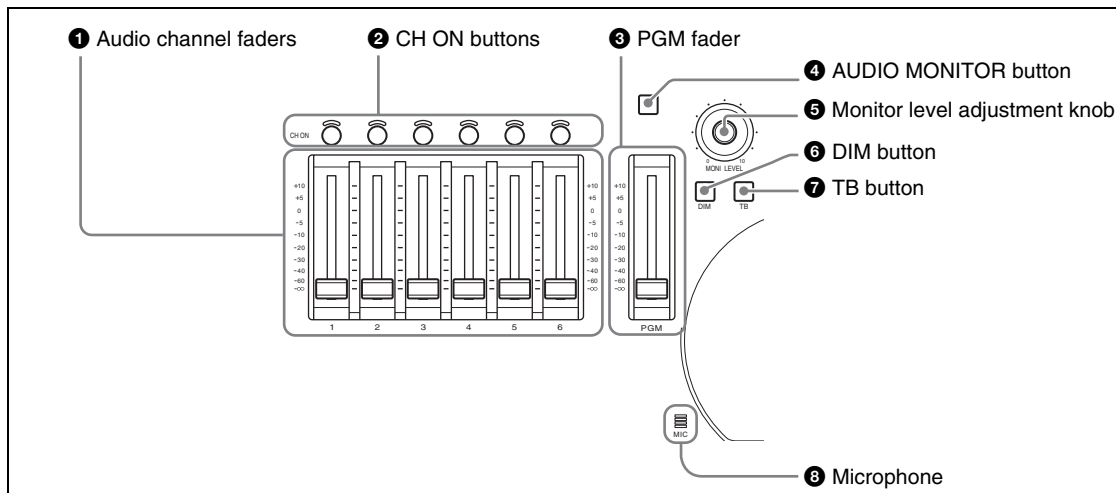

1 Audio channel faders

These buttons adjust the input levels of the audio assigned to channels 1 to 6, in the range from $-\infty$ to +10 dB (page 129).

For details of audio signal assignment, see page 54.

2 CH ON buttons

These buttons select whether the audio channels 1 to 6 are enabled or disabled.

Pressing a button enables the audio assigned to the corresponding audio channel. Channels for which the button is off are disabled.

3 PGM fader

This button adjusts the overall audio output level of the program output, in the range from $-\infty$ to +10 dB (page 129).

4 AUDIO MONITOR button

This button switches the monitoring target. Pressing it cycles the audio to be monitored through the sequence PGM → AUX1 → AUX2 → MIX → PGM.

5 Monitor level adjustment knob

This knob adjusts the level of the monitor output and the output from the internal speakers and from the headphones.

6 DIM button

This button enables the “audio attenuate” function. This reduces each of the level of the monitor output and the output from the internal speakers and from the headphones by 20 dB.

7 TB button

This button lets you to speak while communicating on an external intercom system. While the TB button is lit, sound from the front panel microphone and headset microphone is output over the intercom system.

8 Microphone

This button lets you speak on an external intercom system. While the TB button is lit, sound from the microphone is output over the intercom system.

3 Video switcher section

This switches video.

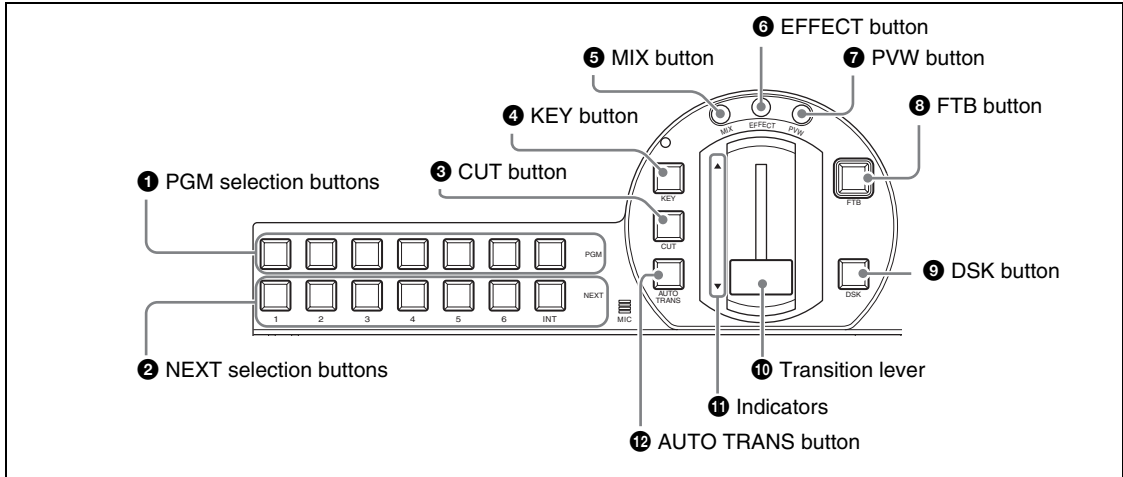

1 PGM selection buttons

These buttons select the video which will be displayed on the program output (page 60). Buttons 1 to 6 select the corresponding assigned video, and the INT button selects a video image generated internally by this unit (color matte, color bars, graphics files).

When you press one of these buttons, lighting it red, the video assigned to the button is sent to the program output.

For details of video assignment, refer to page 53.

2 NEXT selection buttons

The NEXT selection buttons have the following functions.

- Selecting the video to be output on the program output after next switching transition (page 61)
- Selecting the video to be used when inserting a key in the program output (page 74)
- Specifying a camera to be controlled during camera control operations (page 122)
- Selecting the video for recording or playback (page 132, 134)

Buttons 1 to 6 select the corresponding assigned video, and the INT button selects a video image generated internally by this unit (color matte, color bars, graphics files).

3 CUT button

This button instantaneously switches the video (page 59).

4 KEY button

This button effectuates keying (pages 74). When this key lights green, the NEXT selection buttons,

MIX button, AUTO TRANS button, CUT button, and transition lever are then assigned to keying.

5 MIX button

This button effectuates a dissolve (gradually blending a new video into the existing image). When applying an effect it gradually blends in the effect (page 63).

6 EFFECT button

This button enables an effect other than dissolve in a transition or when applying an effect (page 64).

7 PVW button

With this button you can check the result of keying before switching it to program output, on the PVW viewer (page 76).

8 FTB button

This button fades the video in from or out to a black screen (“fade-to-black”) (page 67).

9 DSK button

This button add is used to images or text to the program output video (page 69). You can use it to superimpose text and so on.

10 Transition lever

This lever allows you to manually execute a transition or effect (page 63).

11 Indicators (▽△)

These indicators show the direction in which the transition lever is being moved. Moving the transition lever in the direction of the lit indicator starts the transition or effect.

However, supposing you press the AUTO TRANS button after moving the transition lever to the middle, for example, an inconsistency between the position of the fader and the application of the effect will arise and both indicators will light.

12 AUTO TRANS button

This button carries out an automatic transition with a preset transition time, either from one video to another or when applying an effect (page 63).

4 Device control section

Use these controls for remote control of a camera with VISCA support connected to this system (page 121) or hard disk operations (material recording, file playback, formatting) (page 131, 134, 160).

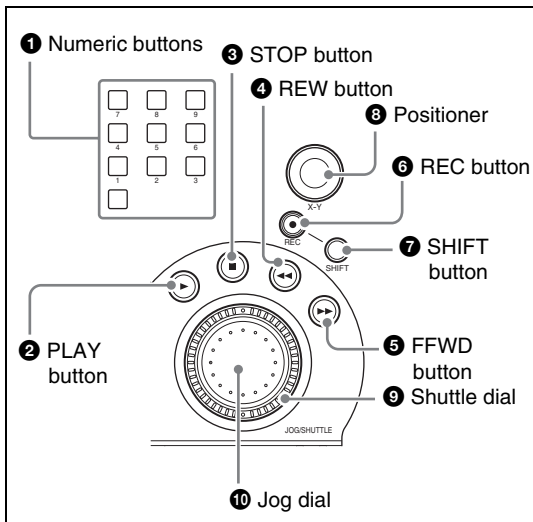

1 Numeric buttons

These buttons are used to save or recall a camera preset (page 123).

2 PLAY button

This button plays back a file at normal speed. Hold down the REC button and press this button, to start recording on the hard disk (page 131).

3 STOP button

This button stops file playback. Use it also to switch the source viewer back from viewing a file on the hard disk to normal input (page 136). During recording on the hard disk, hold down the REC button and press this button to stop recording (page 134).

4 REW button

During file playback, play back fast in the reverse direction. Each time you press, the reverse speed increases (in six steps) (page 136).

5 FFWD button

During file playback, play back fast in the forward direction. Each time you press, the playback speed increases (in six steps) (page 136).

6 REC button

This button is used to start or stop the external hard disk recording (page 133).

REC + PLAY button	Start hard disk recording
REC + STOP button	Stop hard disk recording

7 SHIFT button

This button is pressed while using other controls to perform the following operations.

SHIFT + jog dial	Aperture (iris) adjustment on camera with VISCA support
SHIFT + numeric button (1 to 6)	Set camera presets
SHIFT + numeric button (0)	Camera reset
SHIFT + REW button	Skip to the beginning of a file
SHIFT + FFWD button	Skip to the end of a file

8 Positioner

This control is used to pan or tilt the camera. You can also control the speed of the camera by adjusting how hard you press this button.

9 Shuttle dial (outer ring)

This dial controls the camera zoom.

10 Jog dial (inner dial)

This dial controls the camera focus and iris.

Rear Panel

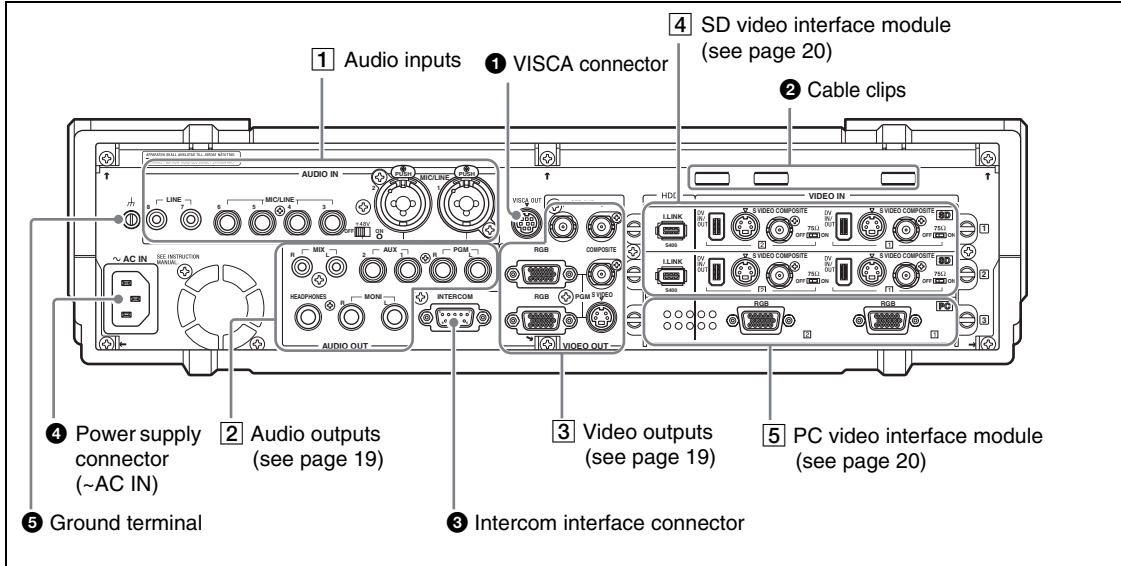

1 VISCA connector

To connect the chain of cameras with VISCA support to this unit for remote control operation, connect the VISCA cable (page 46).

2 Cable clips

Use these clips to prevent cables from accidentally disconnecting.

3 Intercom interface connector

Connect an external intercom system (page 141).

4 Power supply connector (~AC IN)

Use to connect to an AC outlet (page 37).

Caution

When using a DC-AC inverter, the use of a 50 Hz ($\pm 3\%$) or 60 Hz ($\pm 3\%$) sine wave is recommended. Do not use a general-purpose inverter with a square output waveform.

5 Ground terminal

When using this unit, connect the ground terminal to a grounding lead.

Caution

The ground terminal is close to the audio input connectors, so when connecting the grounding lead be careful not to touch the audio input connectors.

1 Audio inputs

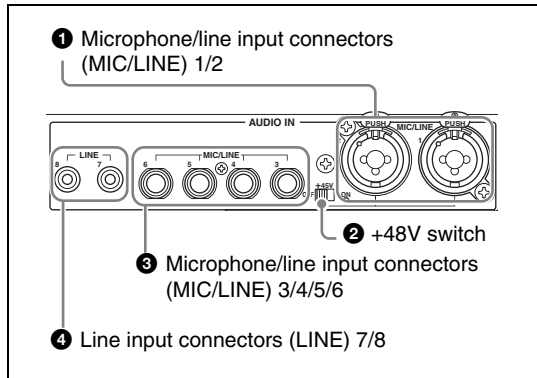

1 Microphone/line input connectors (MIC/LINE) 1/2 (XLR 3-pin, TRS shared balanced type)

Input an analog audio signal from a microphone or audio device.

2 +48V switch

Use this switch when a capacitor microphone requiring a power supply is connected to the microphone/line input connectors (MIC/LINE) 1/2. When this is in the ON position, +48V is supplied.

3 Microphone/line input connectors (MIC/LINE) 3/4/5/6 (TRS balanced type)

Input an analog audio signal from a dynamic microphone or audio device.

4 Line input connectors (LINE) 7/8 (RCA)

Input an analog audio signal from an audio device.

2 Audio outputs

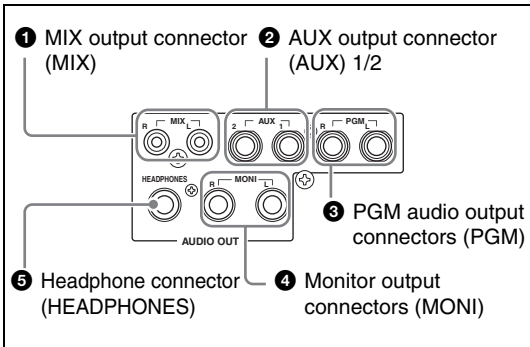

1 MIX output connector (MIX) L/R (RCA)

These connect to an external acoustic device to output audio signals.

2 AUX output connector (AUX) 1/2 (TRS, balanced)

These connect to an external acoustic device to output audio signals. The output level can be adjusted.

3 PGM audio output connectors (PGM) L/R (TRS, balanced)

These output the final audio (program audio) created by this unit.

4 Monitor output connectors (MONI) L/R (RCA)

These provide monitor outputs of any of the PGM/AUX1/AUX2/MIX audio.

5 Headphone connector (HEADPHONES) (standard phone jack)

This outputs one of the PGM/AUX1/AUX2/MIX audio (page 143).

The output level can be adjusted with the front panel monitor level adjustment knob (MONI LEVEL).

3 Video outputs

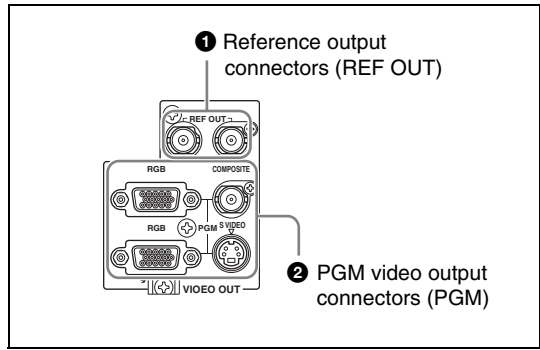

1 Reference output connectors (REF OUT) × 2

These output either a 59.94 Hz (NTSC) or 50 Hz (PAL) black burst signal to match the program output signal.

2 PGM video output connectors (PGM)

- Composite video output connector (COMPOSITE) (BNC) × 1
- S-video output connector (S VIDEO) (S connector) × 1
These output the final program (PGM) video. You can switch to NTSC or PAL (page 54).
- RGB output connectors (RGB) (D-sub 15-pin) × 2
These output the final program (PGM) video as analog RGB signals and video RGB signals. Connect a projector or external display. The following signals can be output (page 54).
 - XGA (1024 × 768) 60 Hz/75 Hz
 - SXGA (1280 × 1024) 60 Hz
 - 15k RGB 50 Hz/59.94 Hz

4 SD video interface module (BKAW-570)

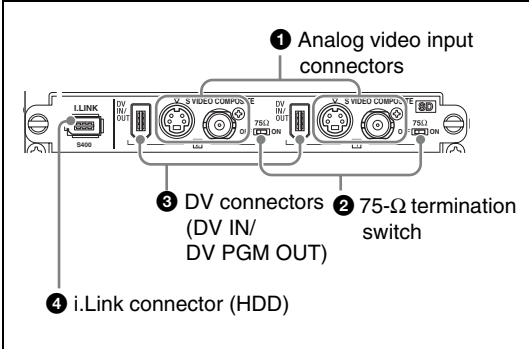

- 1 Analog video input connectors**
Composite video input connectors (COMPOSITE) (BNC) × 2
S-video input connectors (S connector) × 2
 Input analog video signals.

- 2 75-Ω termination switch**
 Set this switch to the OFF position when using a loop-through connection for a video monitor or the like by connecting a branch connector to the composite video input connector (COMPOSITE).

Note

The factory default setting is ON.
 Use the end of a sharp implement such as a pen to operate the switch.

- 3 DV connectors (DV IN/DV PGM OUT) (i.LINK 6-pin) × 2**
 Input and output digital video audio signals.

Notes

- Only one of the Composite/S Video/DV inputs can be used for each of IN1 and IN2.
- When the DV connector is set for output, the Composite and S Video connectors are also not available for input.

- 4 i.LINK connectors (HDD) (i.LINK 6-pin) × 1**
 When a hard disk drive is connected, video input to the same module and audio with the same source number as the video can be recorded in combination (page 131).

5 PC video interface module (BKAW-550)

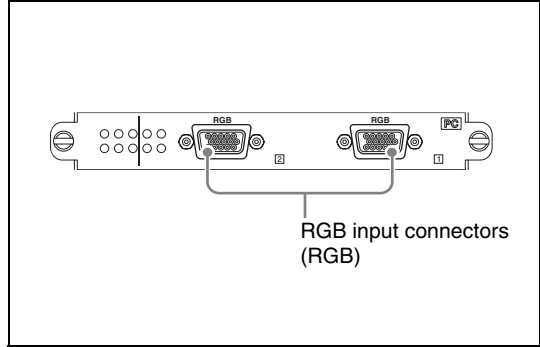

RGB input connectors (RGB) (D-sub 15-pin) × 2

Input analog RGB signals from a computer or other source. The following image size and frequency combinations are supported.

- XGA (1024 × 768) 60 Hz 75 Hz
- SXGA (1280 × 1024) 60 Hz

Side Panel

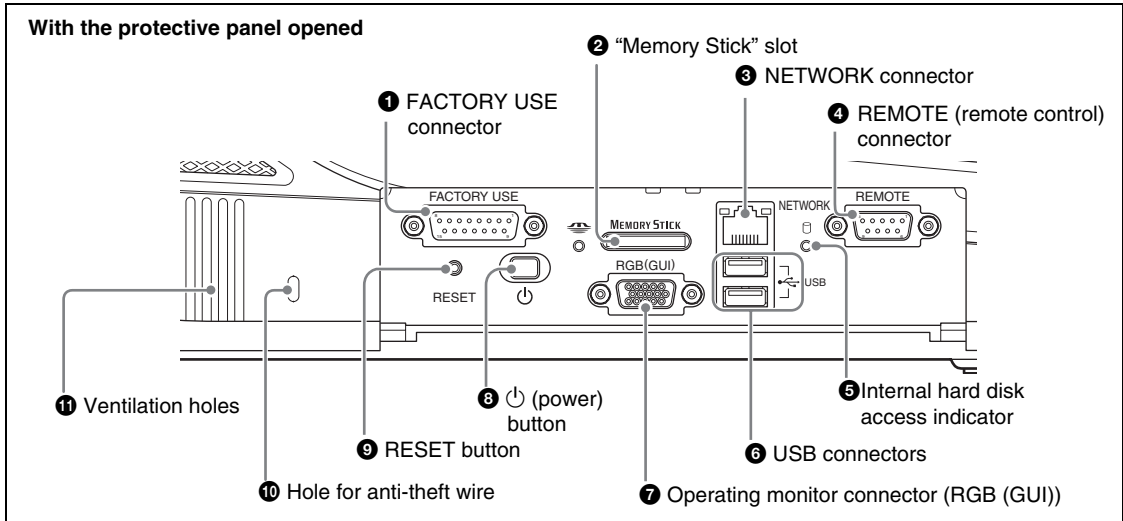

1 FACTORY USE connector

This connector is provided for future functional expansion.

2 “Memory Stick” slot

This slot takes a “Memory Stick.” Use it for upgrading operating software, importing graphics files, and so on.

While the “Memory Stick” is being accessed, the access indicator to the left of the slot lights.

3 NETWORK connector (RJ-45)

Connect an external network adaptor or router. This supports 10Base-T and 100Base-TX Ethernet.

The green indicator blinks while the network is active.

An amber LED lights while the unit is connected by 100Base-TX.

Caution

When making Network connections

For safety, do not connect the Network connector to circuits which may be subjected to excessive voltage.

4 REMOTE (remote control) connector

This connector is provided for future functional expansion.

5 Internal hard disk access indicator

This indicator lights while the internal hard disk is being accessed.

6 USB connectors (USB) (USB compatible)

The upper connector is number 1, and the lower connector is number 2.

Use these connectors to connect a USB keyboard.

You can also connect a USB flash memory, and use it for upgrade installation and importing graphics files.

For details of the keyboards that can be used, consult your dealer or your Sony service representative.

When using the text typing tool software, you can connect and use a USB mouse.

Caution

- These do not support input from a USB camera.
- A USB mouse cannot be used with the main software.

7 Operating monitor connector (RGB (GUI) (D-Sub 15-pin))

This connector outputs the operation screen to an external display at WXGA (1280 × 800) size, at 60 Hz.

For information on which devices can be used, consult your dealer or your Sony service representative.

8 (power) button

This button powers the unit on or off. If you hold down the power button for at least 4 seconds, this forces a shutdown.

After a forced shutdown, the settings of the unit may not be preserved.

9 RESET button

This button is provided for future functional expansion.

10 Hole for anti-theft wire

This hole accepts a standard anti-theft wire (3 mm × 7 mm).

11 Ventilation holes

Caution

Be careful not to obstruct the ventilation holes. If the ventilation holes are obstructed, the unit may overheat, leading to fire or breakdown.

Other Parts

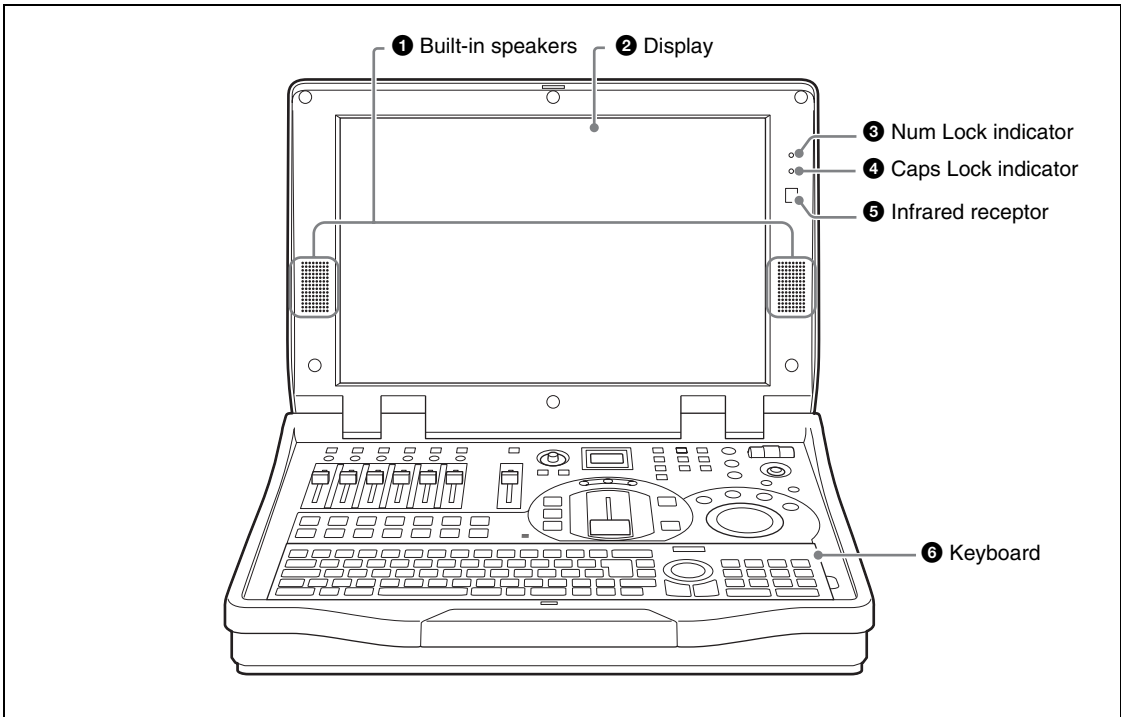

1 Built-in speakers

You can monitor the audio using these speakers. There is no output from the built-in speakers when a headphone is connected to the headphone connector.

2 Display

This shows the operation screen (page 23).

3 Num Lock indicator

This lights green when the unit is in Num Lock mode.

4 Caps Lock indicator

This lights green when the unit is in Caps Lock mode.

5 Infrared receptor

This accepts signals from the keyboard supplied with this unit (page 40).

6 Keyboard

Use this for text and numeric input.

You can also use the keyboard for menu operations (page 28).

While the keyboard is mounted to the unit, the EXT POWER indicator on the keyboard lights green.

When using Esc and the F1 to F12 keys, hold down the Fn key and press the required key in the topmost row.

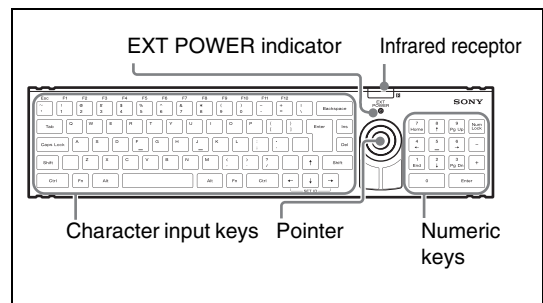

Operation Screen



1 Menu display

This displays the top menus (page 27), the INT material selection menu (pages 69, 147), the camera control guide and camera preset menu (pages 122, 123), and files on the external hard disk (page 134).

2 Guidance object indication

The color of the guidance object indication has the following significance.

Amber: when a video subject to camera control (page 121) or INT is specified with the NEXT selection buttons, (with KEY button off).

Green: when a video subject to camera control or INT is specified with the NEXT selection buttons, (KEY button lit).

Off: when other than a video subject to camera control or INT is specified with the NEXT selection buttons.

3 Audio level meter

When monitoring the any of the PGM/AUX1/AUX2/MIX audio outputs or Pre Fader Listen (PFL) result, this shows the audio level. An indication below the meter shows which of PGM/AUX1/AUX2/MIX or PFL is being monitored. When the level exceeds the meter range, the uppermost indicator lights red.

4 KEY ON

The red indicator blinks while the program output video is effectuated keying.

1 PGM viewer

This shows a program output.

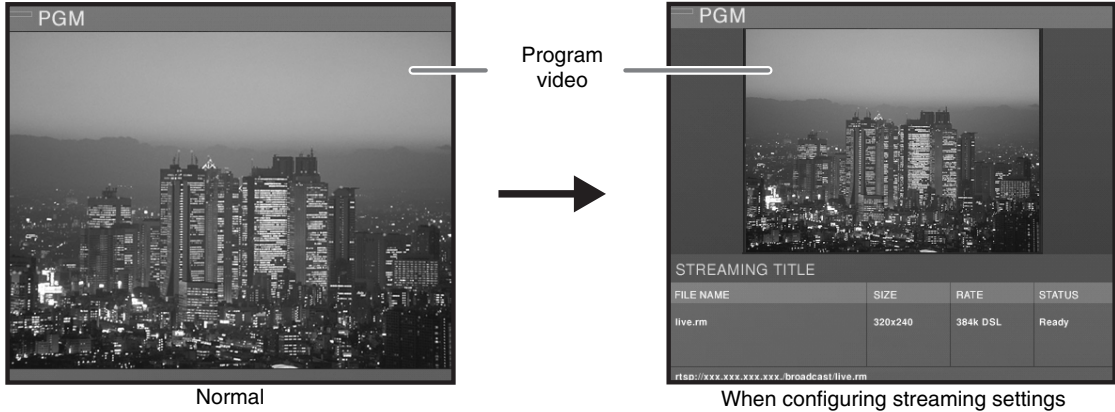

Program video

The program output video is shown at 480×360 pixels, 30 fps (25 fps for PAL). During streaming, the size is 320×240 pixels.

Caution

- Video displayed on the PGM viewer lags several frames behind the video output from the PGM video output connectors.
- In any of the video viewers displayed on the operation screen (PGM/PVW/source) the video may deteriorate, but this is an artifact of the display system. There is no effect on the video output from the program video output connectors.

2 PVW viewer

This shows a preview of the video.

This allows you to check an input video selected to be shown next or a keying result, before switching to program output.

① What the preview is showing



① What the preview is showing

Amber: when showing the video selected by the NEXT selection button.

Green: when showing the video selected by the NEXT selection button when the KEY button is lit (video with a key inserted).

② Preview video

Normally the video selected with the NEXT selection buttons is shown at 320×240 pixels, 15 fps (12 to 13 fps for PAL).

③ Status

This shows the status when using remote control of a camera with VISCA support, the status when recalling an INT graphics file, or the status of a file operation on the external hard disk.

VISCA-compatible camera

Displays the camera's status.

No Response: Communication cannot be established with the camera.

Initializing: Appears at system startup and during camera reset.

INT

Loading: while file is loading

File operations

Opening: while opening a file

▶ **Play:** during playback

■ **Stop:** when stopped

▶▶ **x2:** fast forward (x2, x4, x8, x16, x32, x64)

◀◀ **x2:** fast reverse (x2, x4, x8, x16, x32, x64)

00: 00: 00: 00: timecode

3 Streaming display

This shows the settings and status of the streaming broadcast.

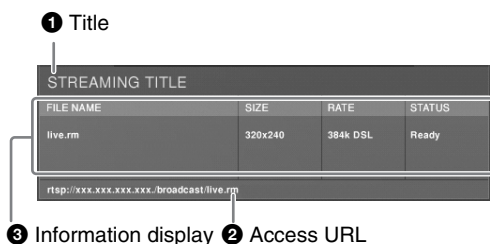

1 Title

This shows the streaming title.

2 Access URL

This appears when the unit is used as a server for a broadcast. Audience members can view the broadcast by accessing this URL.

3 Information display

This shows the following information:

FILE NAME: the file name of the broadcast

SIZE: video size set in the top menu

RATE: transfer rate set in the top menu

STATUS: the status of the server or encoder

Initializing	Starting server or encoder
Ready	Server started up, and encoder ready
Starting	Encoder connecting to server
Running	Encoding
Error	An error occurred

4 Source viewer

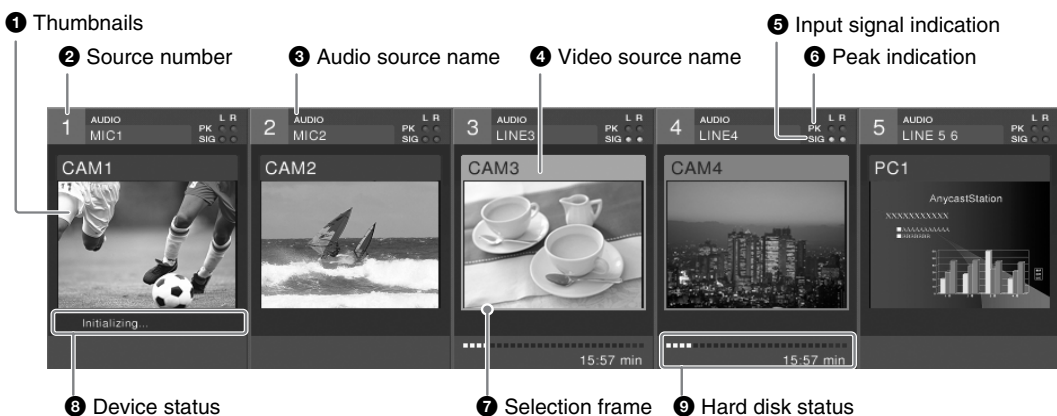

1 Thumbnails

These show the video assigned to the selection buttons at 160 × 120 pixels, at 10 fps (8 to 9 fps for PAL).

2 Source number

This is the number (1 to 6 and INT) assigned to the source (video or audio).

These correspond to the PGM selection button, the NEXT selection button, and the audio channel fader numbers.

3 Audio source name

This shows the name of the audio signal assigned to the channel fader (page 54) or the file name on the external hard disk (page 134).

4 Video source name

In viewers 1 to 6, this shows the name of the video signal assigned to the selection button (page 53) or the file name on the external hard disk (page 134). For the INT viewer, this displays the color matte and color bars, or the graphics file name selected in the INT menu.

5 Input signal indication

If the input level of the audio assigned to a channel fader is -60 dBFS or more, this lights green, and you can check that there is an audio input. For stereo you can check left and right channels separately; for monaural both channels are shown the same.

6 Peak indication

If the input level of the audio assigned to a channel fader is -8 dBFS or more, this lights red. For stereo you can check left and right channels separately; for monaural both channels are shown the same.

7 Selection frame

Depending on the selection state, the frame color changes.

Red: video selected with PGM selection button

Amber: video selected with NEXT selection button

Green: video selected with NEXT selection button when the KEY button is lit (video with a key inserted)

8 Device status

This shows the status when using remote control of a camera with VISCA support, the status when recalling an INT graphics file, or the status of a file operation on the external hard disk.

VISCA-compatible camera

Displays the camera's status.

No Response: Communication cannot be established with the camera.

Initializing: Appears at system startup and during camera reset.

INT

Loading: while file is loading

File operations

Opening: while opening a file

▶ **Play:** during playback

■ **Stop:** when stopped

▶▶ **x2:** fast forward (x2, x4, x8, x16, x32, x64)

◀◀ **x2:** fast reverse (x2, x4, x8, x16, x32, x64)

00: 00: 00: 00: timecode

9 Hard disk status

When an external hard disk is connected, this shows the status of the hard disk, the remaining recording capacity, and the recording status.

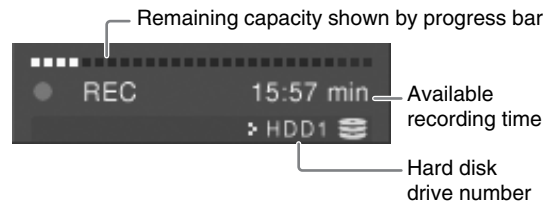

Recording operations

●|| **REC Pause:** recording on standby

● **REC:** recording

Unformatted: error requiring formatting

Disk Full: no disk space left (200 MB or less)

File Number Full: the number of files that can be recorded has been exceeded

Device Error: it became impossible to recognize the hard disk during recording

REC Error: recording error

5 Effect display

This shows video transition effect types and patterns, and transition time (page 66).



Menu Operations

This unit includes top menus, which are used to make various operational settings, and ACCESS menus, which are used to make adjustments to the video and audio being input to this unit.

This section describes the basic operations common to these menus.

Displaying top menus and ACCESS menus

Top menu

Press the MENU button, to display the top menu in the menu display.

Top menu



When you select and confirm an item in the top menu, submenus appear, three levels deep.

Sub-menu

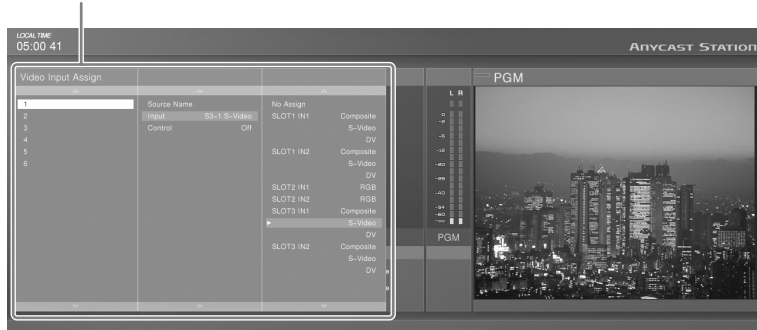

ACCESS menu

Press the ACCESS button corresponding to the number of input you want to adjust, to display the ACCESS menus, three levels deep, in the source viewer together with the viewer for that number.

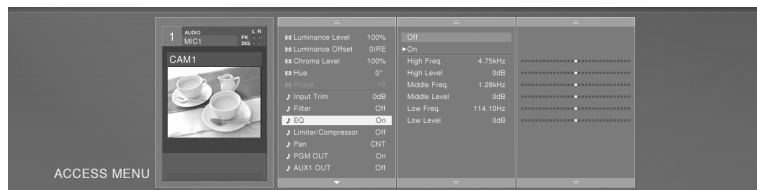

Menu operations

Selecting a menu item

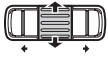

Turn the jog roller up or down.
You can also use the ↑ and ↓ keys on the keyboard.

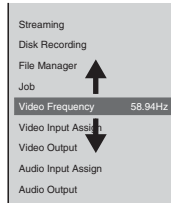

Confirming an item and proceeding to the next layer



Press the ENTER button.
or

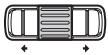

Press the jog roller.
or

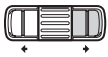

Press the → button by the jog roller.
You can also use the → key or ENTER key on the keyboard.

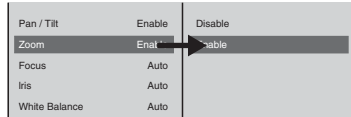

Returning to the higher level

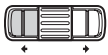

Press the ← button by the jog roller.
You can also use the ← key on the keyboard.

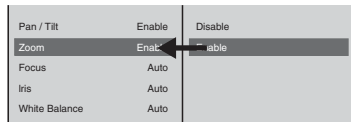

Confirming a selection

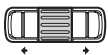

Press the ENTER button.
or
Press the jog roller.

You can also use the ENTER key on the keyboard.

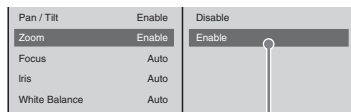

Confirmation

Slider operation

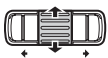

Turn the jog roller up or down.
You can also press ↑ or ↓ on the keyboard.



Entering numeric or text values

Moving the cursor to the next item:

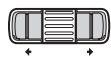

Press the ← or → button by the jog roller.

You can also press the ← or → keys while holding down Ctrl on the keyboard.

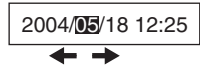

Entering numeric or text values:

Enter with the keyboard.

Confirmation:



Press the ENTER button.
or
Press the jog roller.

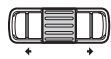

You can also use the ENTER key on the keyboard.

Closing a menu

For a top menu: Press the MENU button or ESC button.

For an ACCESS menu: Press the same ACCESS button used to display, or the ESC button.

Notes

- While a top menu is displayed, pressing the ACCESS button clears the top menu.
- While an ACCESS menu is displayed, pressing the MENU button clears the ACCESS menu.

Operation screen (Text Typing Tool Software)

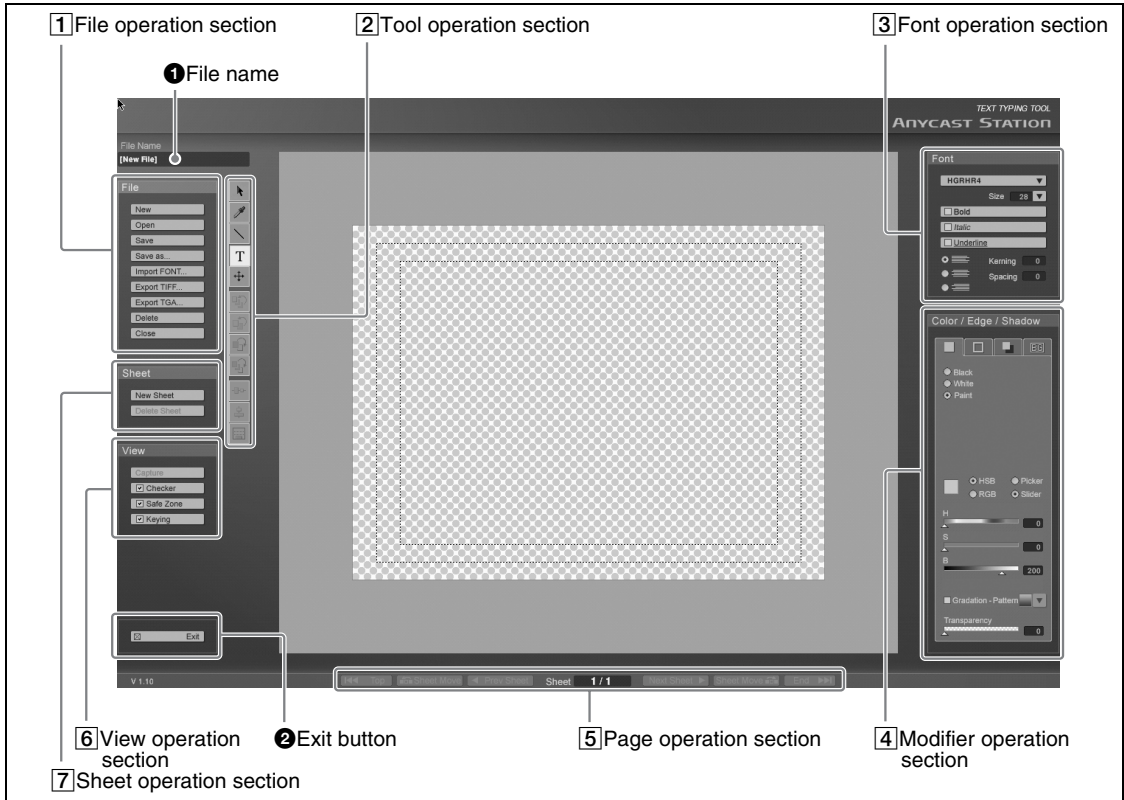

1 File name

This shows the name of the open file.

2 Exit button

Click this to exit the text typing tool software, and start the Anycast Station main software.

1 File operation section

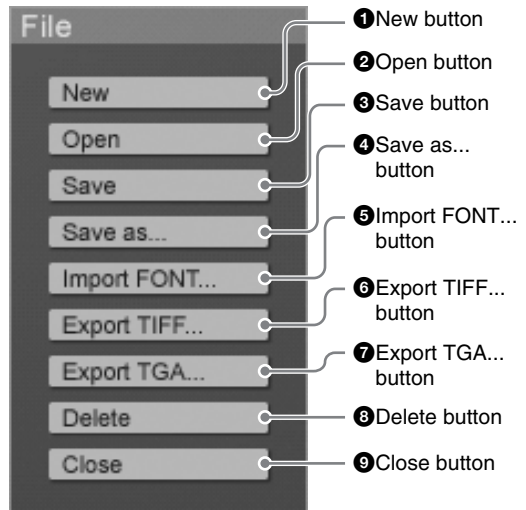

1 New button

This creates a new file (page 88).

2 Open button

This opens a previously saved file. A list of existing files appears (page 88).

3 Save button

This saves a file (page 89).
The file is also simultaneously saved in the Anycast Station main software, and the file name appears in the INT selection menu.

4 Save as... button

This saves the file with a different name (page 90).

5 Import FONT... button

This imports a font file from a “Memory Stick” or USB flash memory (page 119).

6 Export TIFF... button

This saves the open file to a “Memory Stick” or USB flash memory in TIFF format (page 92).

7 Export TGA... button

This saves the open file to a “Memory Stick” or USB flash memory in TARGA format (page 92).

8 Delete button

This deletes unwanted files (page 91).

9 Close button

This closes the open file, and displays a new sheet.

2 Tool operation section

Select the tools needed to create and edit an object.

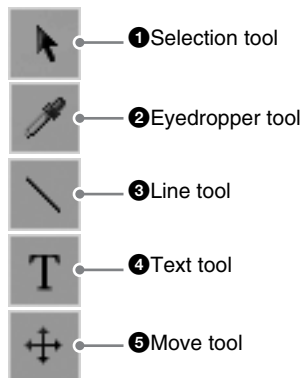
**1 Selection tool**

When you click this, the mouse pointer changes to , and you can select an object (page 87).
An orange frame appears around the selected object.

2 Eyedropper tool

When you click this, the mouse pointer changes to , and you can set the color of the selected object to be the same as the color of another object or the background image (page 109).

3 Line tool

When you click this, the mouse pointer changes to , and you can create a line object (page 101).
You can create three types of line: solid, broken, and dotted.

4 Text tool

When you click this, you can create a text object (page 95).

5 Move tool

When you click this, you can drag an object to move.

Note

When the selection tool or move tool is selected, you can move the selected object with the keyboard arrow keys. Hold down the Shift key while pressing the arrow keys to speed up the movement.

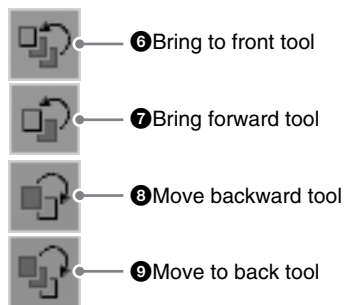
**6 Bring to front tool**

This brings the selected object to the front (page 113).

7 Bring forward tool

This brings the selected object one level forward (page 113).

8 Move backward tool

This moves the selected object one level back (page 113).

9 Move to back tool

This moves the selected object to the back (page 113).

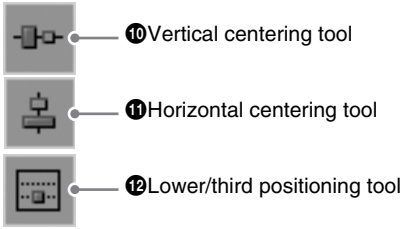

10 Vertical centering tool

This moves the selected object to the vertical center of the screen (page 114).

11 Horizontal centering tool

This moves the selected object to the horizontal center of the screen (page 114).

12 Lower/third positioning tool

This moves the selected object to the bottom of the screen (page 114).

3 Font operation section

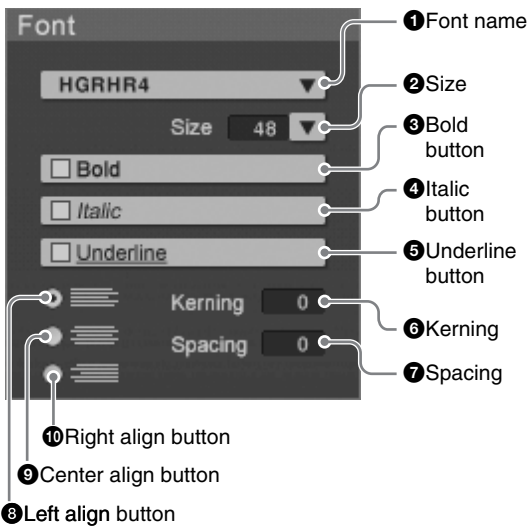

1 Font name

This selects the font for a text object (page 95). The currently selected font always appears.

2 Size

This selects the size of a text object (page 96).

3 Bold button

This sets the text object to bold face (page 98).

4 Italic button

This sets the text object to italic face (page 98).

5 Underline button

This underlines the text object (page 98).

6 Kerning

This sets the inter-character spacing of the text object (page 98).

7 Spacing

This sets the line spacing of the text object (page 99).

8 Left align button

Aligns a text object comprising multiple lines to the left (page 99).

9 Center align button

Aligns a text object comprising multiple lines to the center (page 99).

10 Right align button

Aligns a text object comprising multiple lines to the right (page 99).

4 Modifier operation section

Click the mark on a tab to select it, and bring it to the front.

Color tab

This determines the color of the text object.

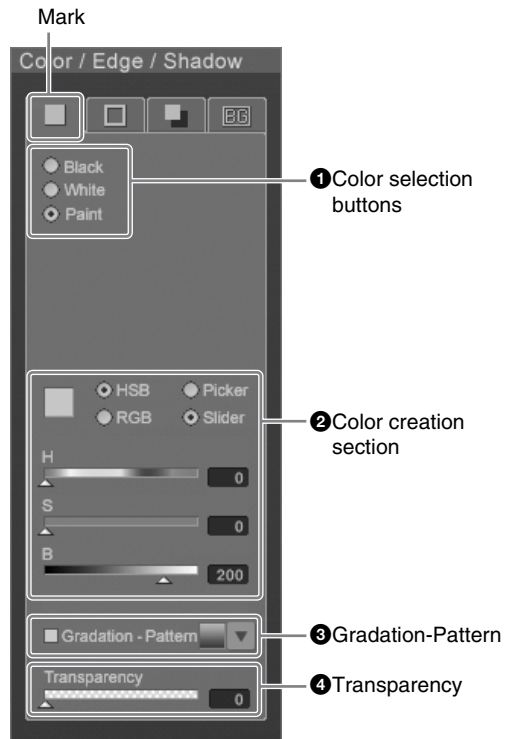

1 Color selection buttons

These select the color of a text object (page 100).

2 Color creation section

When the [Paint] color selection button is selected, you can create your own color for an object (page 108).

3 Gradation-Pattern

Applies a gradation to the color of a text object.

4 Transparency

This sets the transparency of a text object.

Edge tab

This determines the color of text object outlines and the line style and color of line objects.

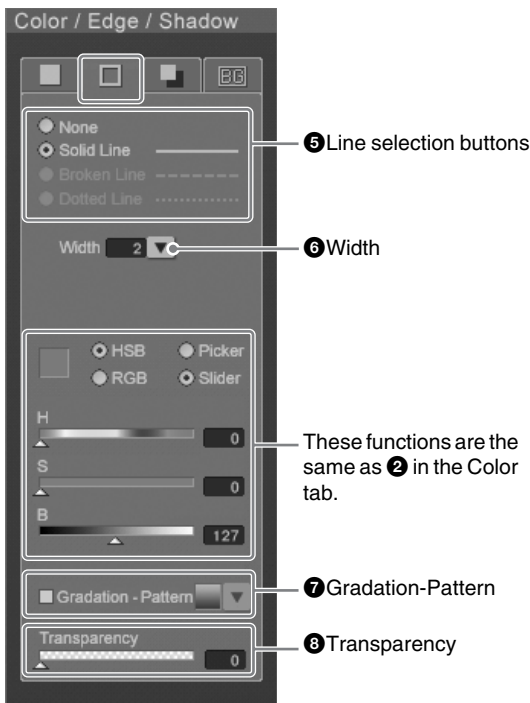

5 Line selection buttons

For a text object, these select whether an outline is applied to the text (None or Solid Line) (page 101).

For a line object, they select the line style (page 102).

6 Width

This selects the width of the outline around a text object or of a line object. Select or enter a numeric value (page 101, 103).

7 Gradation-Pattern

Applies a gradation to the color of a line object.

8 Transparency

This sets a numeric value for the transparency of the line object.

Shadow tab

This applies shadow to an object.

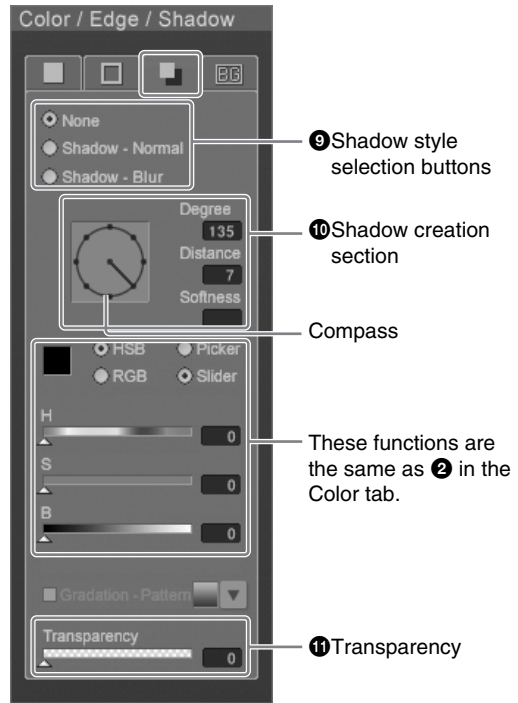

9 Shadow style selection buttons

These select whether to apply no shadow (None), or select the type of shadow.

10 Shadow operation section

Adjust the shadow angle and distance, and degree of blurring.

Compass: Clicking this moves the needle, and the shadow of the object changes to the same direction as the needle.

Degree: Enter the direction of the shadow as a numeric value.

Distance: Enter the distance from the object to the shadow as a numeric value.

Softness: Enter the degree of blurring of the shadow as a numeric value.

11 Transparency

This sets a numeric value for the shadow transparency.

■ Background tab

This determines the background color.

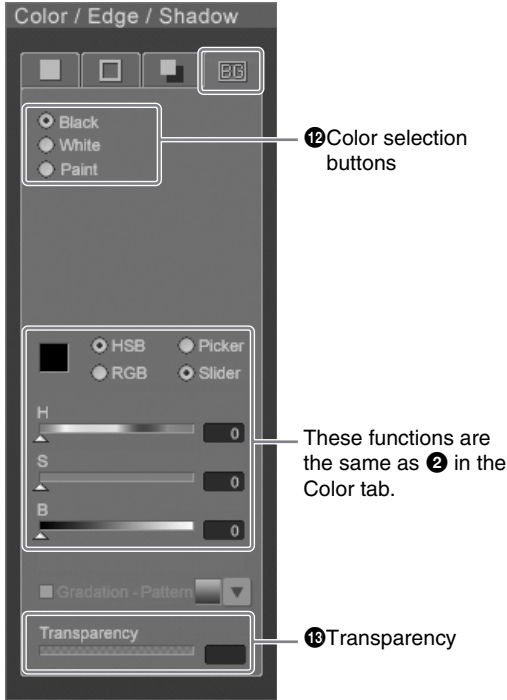

12 Color selection buttons

These select the background color (page 106).

13 Transparency

This sets the background transparency.

5 Page operation section

This is used for sheet display, sheet turning, and resequencing.

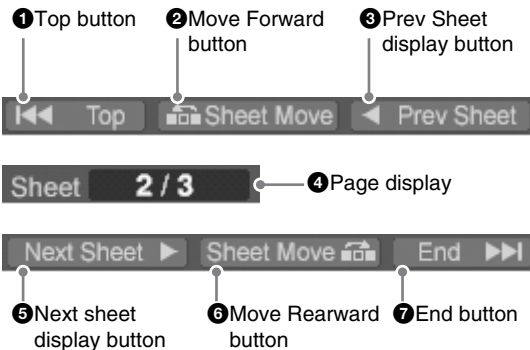

1 Top button

Click this to display the first sheet.

2 Move Forward button

Click this to exchange the currently displayed sheet with the previous sheet.

3 Prev Sheet button

Click this to display the previous sheet.

4 Page display

This shows the sheet number of the currently displayed sheet.

5 Next Sheet button

Click this to display the next sheet.

6 Move Rearward button

Click this to exchange the currently displayed sheet with the next sheet.

7 End button

Click this to display the last sheet.

6 View operation section

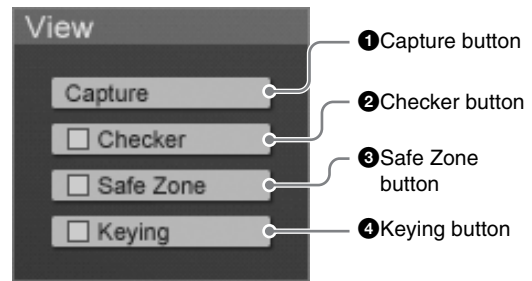

1 Capture button

This captures the program output video image from the Anycast Station main software (page 116). You can display the captured image in the background, to check the effect of keying.

Note

To display the captured image in the background, it is necessary to select the [Keying] button (4), and unselect the [Checker] button (2).

2 Checker button

When this is selected, a checkered pattern appears in the background (page 117).

3 Safe Zone button

When this is selected, a dotted line shows the safe zone (page 118).

4 Keying button

When this is selected, a captured image from program output video or a checkered pattern is displayed in the background. You can use it to check the effect of keying (page 117).

7 Sheet operation section

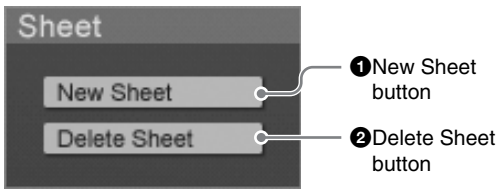

1 New Sheet button

This adds a sheet to the open file (page 115). You can create up to 99 sheets.

2 Delete Sheet button

This deletes the open sheet (page 116).



Installation/Default Settings

This section describes the procedure for installing the unit, connecting the power cord, starting up the system, and setting the date, time, and video output signal format.

Installing the Unit

Install the unit in a level place. The unit weighs about 17.7 lbs (8 kg). Check that the installation location is strong and spacious enough to accommodate the unit before installing.

There are ventilation holes on both sides of the unit. To ensure adequate air flow, there must be a space of at least 12 inches (300 mm) on each side of the unit.

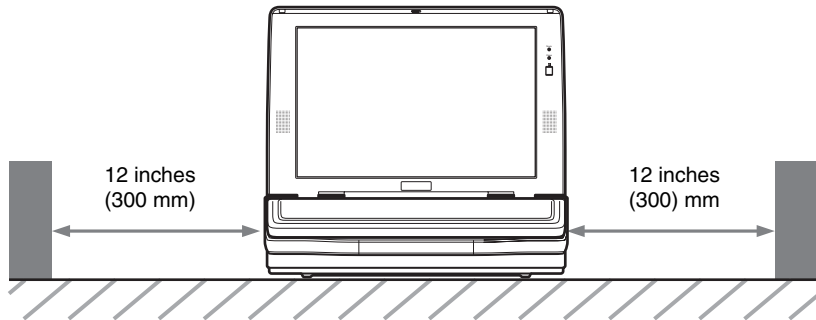

Connecting the power

Connect the power cord to the power inlet on the unit and the wall outlet.

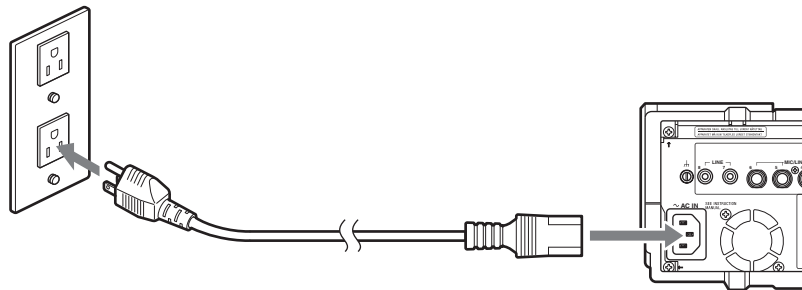

Note

Use a 3-pin - 2-pin conversion adaptor, if required.

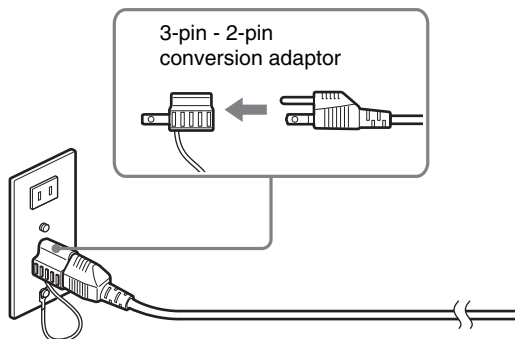

Caution

Connect the grounding lead of the 3-pin/2-pin adaptor to the ground terminal. If grounding is not possible, consult your dealer or your Sony service representative.

Fitting a Keyboard

To install the keyboard in this unit, align it with the keyboard space, with the keys upward, and slide in the direction shown by the arrow. Power is supplied to the keyboard from the main unit, and the EXT POWER indicator on the keyboard lights.

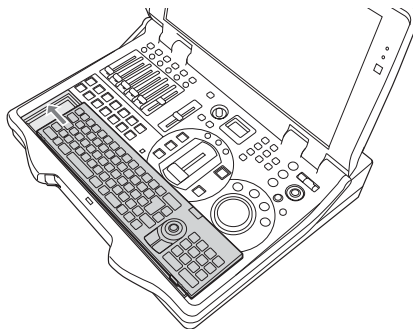

Note

When not using the keyboard, you can insert it upside down. In this case, no power is supplied to the keyboard.

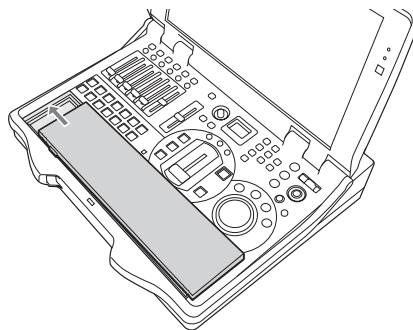



Using the keyboard away from the unit

You can use the keyboard away from the unit. In this case, it is necessary to insert a pair of standard batteries (CR2032) to power the keyboard.

Detaching the keyboard

Using the groove locating at the right of the keyboard space, lift the keyboard out.

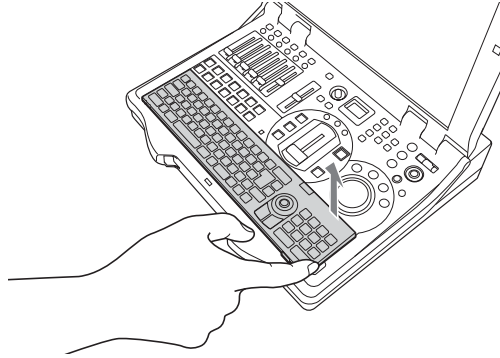

Inserting batteries in the keyboard

- 1 Detach the keyboard from the main unit.
- 2 Detach the battery holder from the keyboard.

Caution

To remove the battery holder, use the end of a sharp implement such as a pen.

- 3 Load two batteries (CR2032) in the battery holder, and insert in the keyboard.

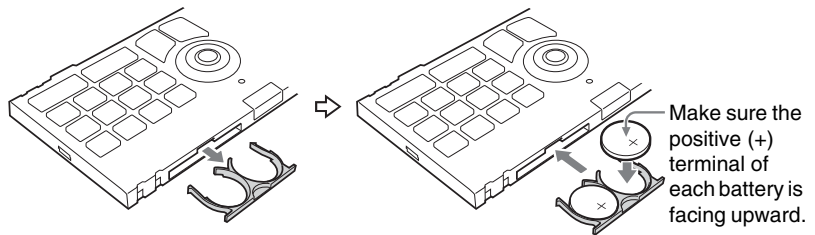

Caution

If batteries are inserted incorrectly, this may lead to electrolyte leakage or other damage. Note the following carefully.

- Check that the polarity is correct.
- Do not use new and old batteries together, or batteries of different types.
- Do not attempt to charge the batteries.
- When not using the keyboard for a long period, remove the batteries.
- If a battery should leak, remove any spilled fluid from the battery holder, before inserting a new battery.

Infrared transmitting range

The range over which the keyboard can operate with infrared control is shown in the following figure.

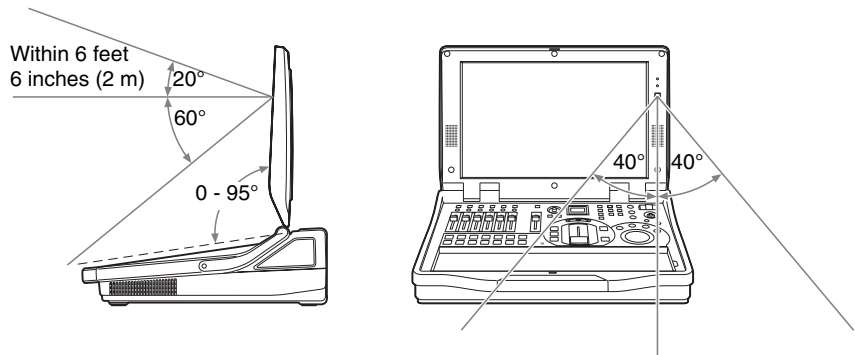

Starting and Closing Down the Unit

Starting

Press the  (power) button on the side panel.
The startup screen appears.

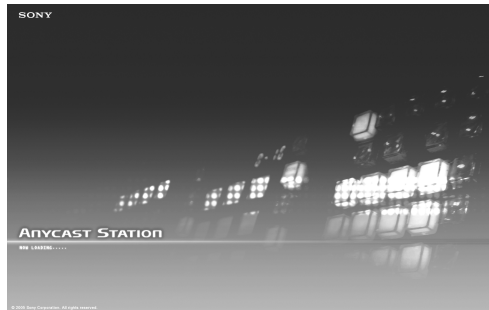

When the startup completes, the operation screen appears.

Caution

If the display is closed while the unit is operating, the temperature will rise, and this may cause failure.

Closing down

Press down the  (power) button on the side panel.
The following message appears.

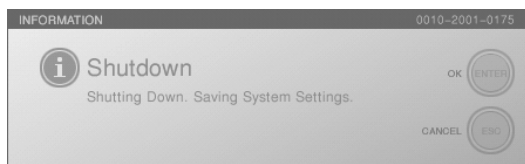

Notes

- The last set data is saved.
- If an external hard disk is connected, it is automatically unmounted (page 137).

This closes down the operating software, and powers off.

Caution

If you hold down the power button for at least 4 seconds, this forces a shutdown. After a forced shutdown, the settings of the unit may not be preserved.

Using the timer to shut down the system/Releasing the timer setting

- 1 While the Anycast Station main software is running, hold down the keyboard Alt and Ctrl keys, and press the T key. The following confirmation message appears.

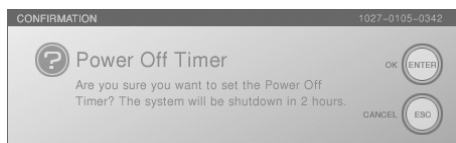

Note

It is not possible to use this function while the text typing tool software is running.

- 2 To set the timer, press the ENTER button. To release the timer, press the ESC button.

When setting the timer

The timer indication appears to the right of [LOCAL TIME].



When the text entry tool is started, the timer display disappears, but the timer function continues to operate.

Note

The countdown appears from -120 min.

After two hours the system is powered off.

When releasing the timer

The timer display disappears.

Selecting the Keyboard Language

Set the language to correspond to the keyboard being used.
The default setting is “English.”

- 1 Press the MENU button.
- 2 In the top menu, select [Language].
- 3 Select the appropriate language from the list, and confirm.



The operation screen appears as shown below.

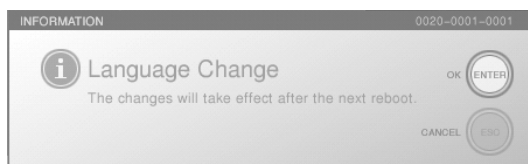

- 4 Confirm the message that appears, and press the ENTER button.
- 5 Press the MENU button to close the menu.
- 6 Restart the system.

Setting the Time Zone

Set the time zone for your geographical location.

- 1 Press the MENU button.
- 2 In the top menu, select [Date/Time].
- 3
 - ① Select [Time Zone], and confirm;
 - ② select the area, and confirm;
 - ③ select the region, and confirm.

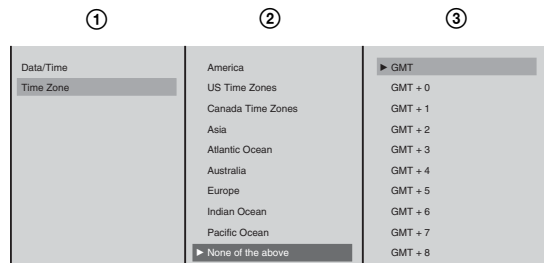

- 4 Press the MENU button to close the menu.

Note

The notation system for displaying time zone data in relation to GMT is based on the form POSIX minutes-west-of-GMT in which the hour decreases as you move east and increases as you move west.

Setting the Date and Time

Set the internal clock.

- 1 Press the MENU button.
- 2 In the top menu, select [Date/Time].
- 3 ① Select [Date/Time], and confirm; ② enter the date and time in the input box, and confirm.

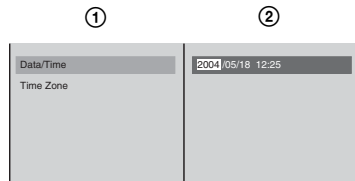

Using the arrow buttons on the jog roller (or the ← and → keys while holding the Ctrl key on the keyboard), select the item to change and enter a numeric value with the keyboard.

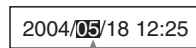

Each whole value between the separators (/, :, or space) is selected.

The date and time set in [Local Time] appears at the upper left of the operation screen.

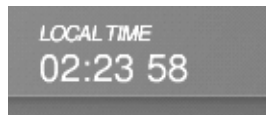

- 4 Press the MENU button to close the menu.

Caution

If this unit is operated for a long period, the clock may drift out of its correct setting. Resetting the clock at regular intervals is recommended.

Adjusting the Display Brightness

Adjust the brightness of the display on which the operation screen is shown.

- 1 Press the MENU button.
- 2 In the top menu, select [LCD Backlight].
- 3 Move the slider to adjust the brightness.



- 4 Press the MENU button to close the menu.

Selecting the Video Output Signal Format

Select the format of the signal output from the PGM output connectors (COMPOSITE/S VIDEO), SD video interface module DV connectors, and the reference output connector on the rear panel.

- 1 Press the MENU button.
- 2 In the top menu, select [Video Output].
- 3 ① Select [PGM OUT], and confirm; ② select the signal format, and confirm.

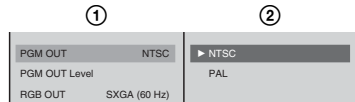

- 4 Press the MENU button to close the menu.

Caution

Carrying out this selection may cause momentary breakup of the output video.

Note

Video input in a different signal format than this setting can still be displayed (i.e., displaying a PAL video input when set to “NTSC” or vice versa), but the video quality cannot be guaranteed.

Connections

This section describes how to connect devices for video and audio input and output. The following figure shows an example system configuration and signal flow. Refer to the pages indicated for details of how to make connections. In addition, after connecting each device, you must configure settings on the unit for each input and output signal. Refer to page 52 for details on the settings of each input and output signal.

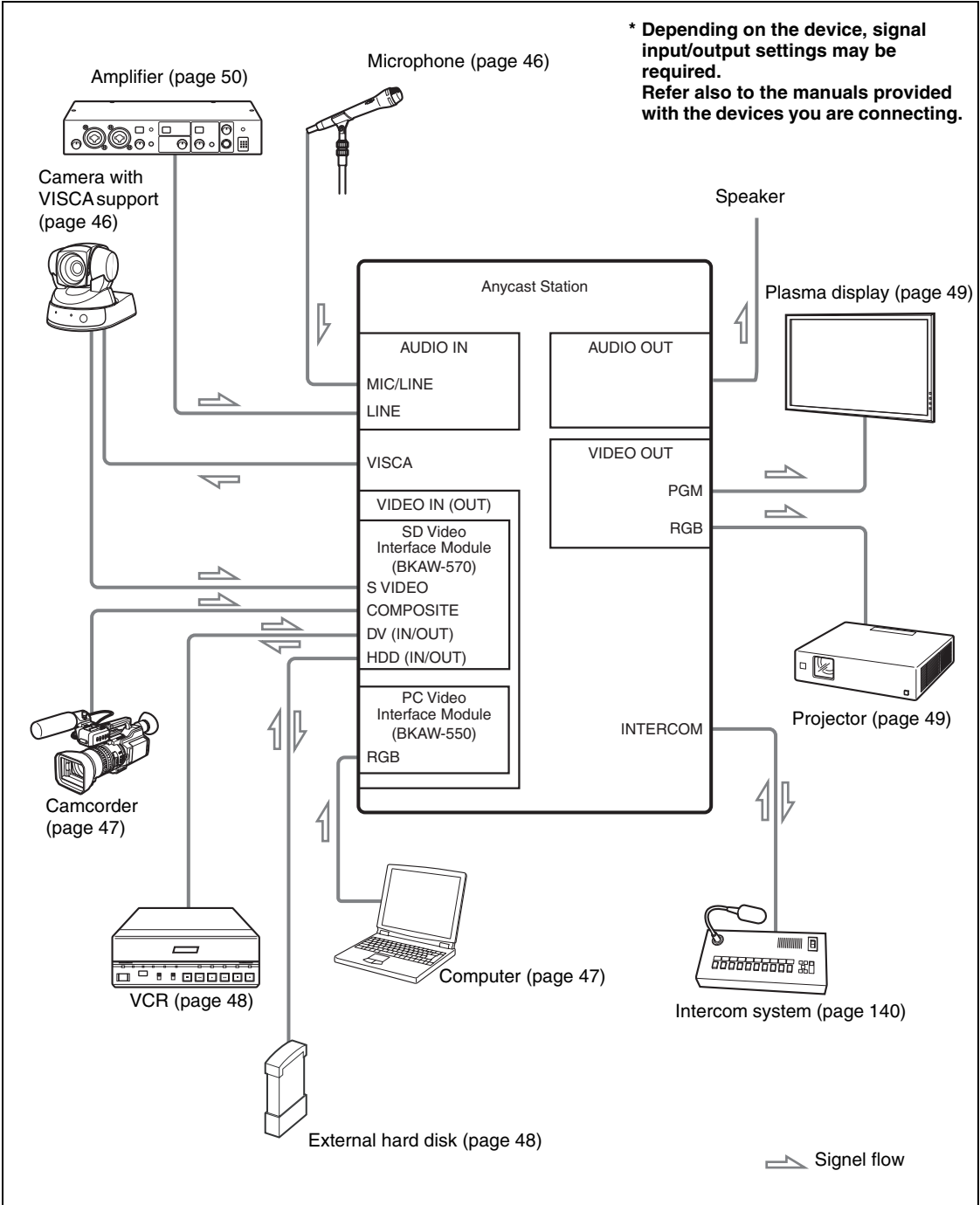

Caution

- Use the shortest possible cable type (especially with unregulated RGB). Shorter cables are recommended because, in general, using long cables to connect devices increases the risk of signal noise. Even when connecting this unit to another, it is best to use the shortest cables possible.
- Be careful with the connector portions of the interface modules, which may become hot depending on the conditions of operation.

Connecting a Camera with VISCA Support

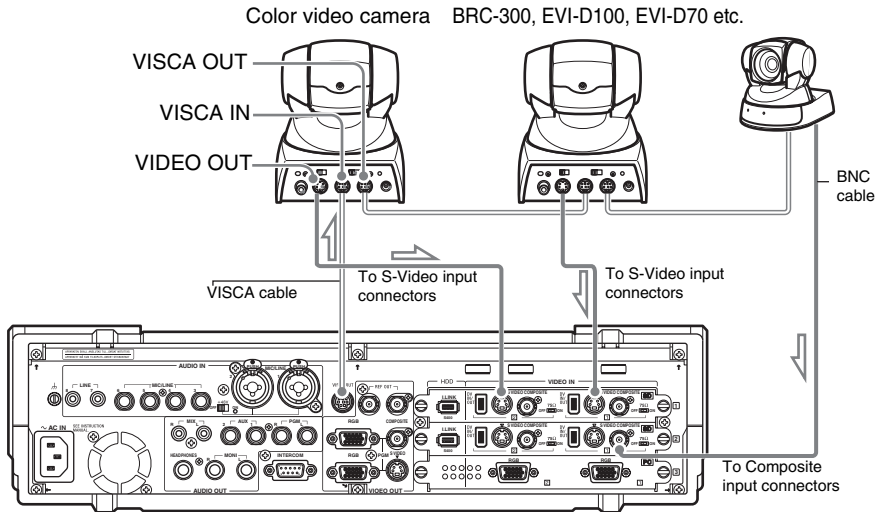

Notes

- VISCA cables up to 15 m (50 ft) are recommended to operate correctly.
- When connecting a BNC cable, an RCA-BNC adaptor is required.

Connecting a Microphone

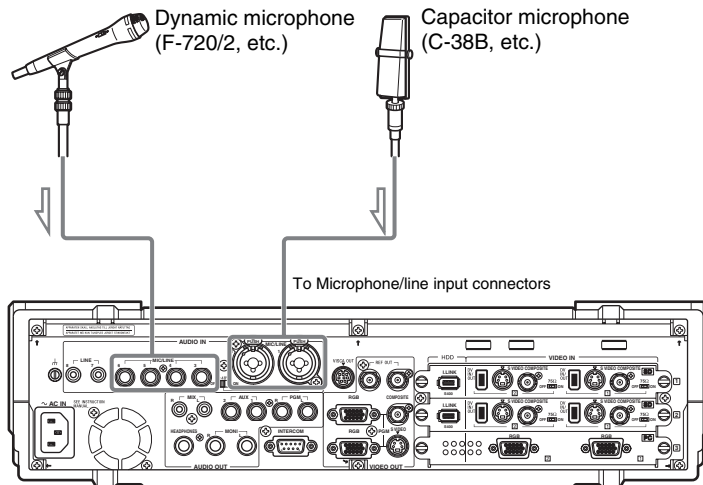

Connecting a Computer (RGB Input)

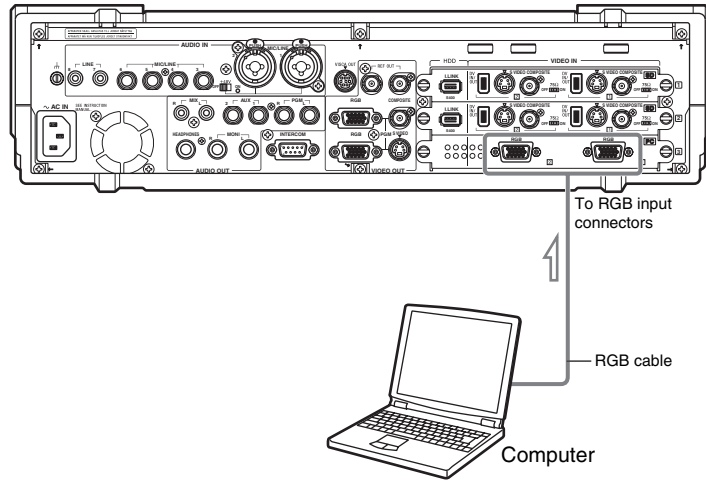

Note

To reduce the effects of external noise, use a cable with an attached ferrite core.

Connecting a Camcorder

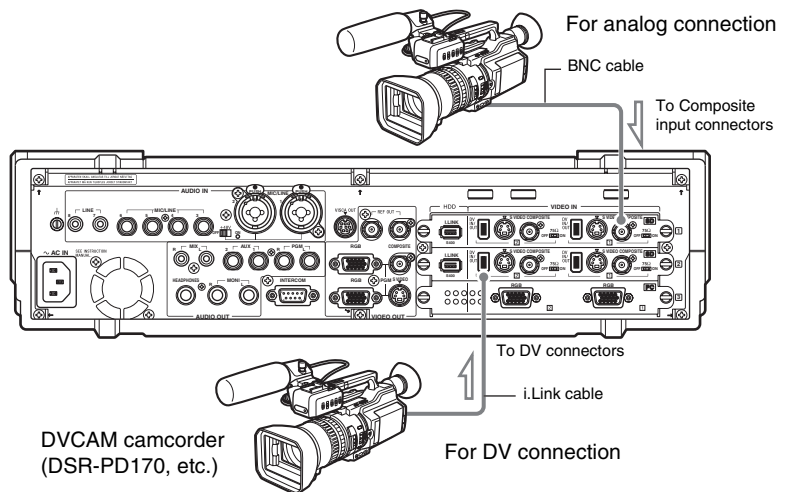

Note

i.LINK cables between 80 cm and 3.5 m (2.5 to 11.5 ft) are recommended.

Caution

- The frequency precision of the reference output signal is within 50 ppm. When building a system that includes devices such as a camera with a Gen Lock input, be sure to test it thoroughly before use.
- The color frame of the program output signal does not reflect the color frame sequence of the reference output signal.

- If video or audio is not output or signal noise occurs when connected to another DV device, the problem can often be resolved by reconnecting the cables or turning the DV device or the unit off and then on again.

Connecting a VCR

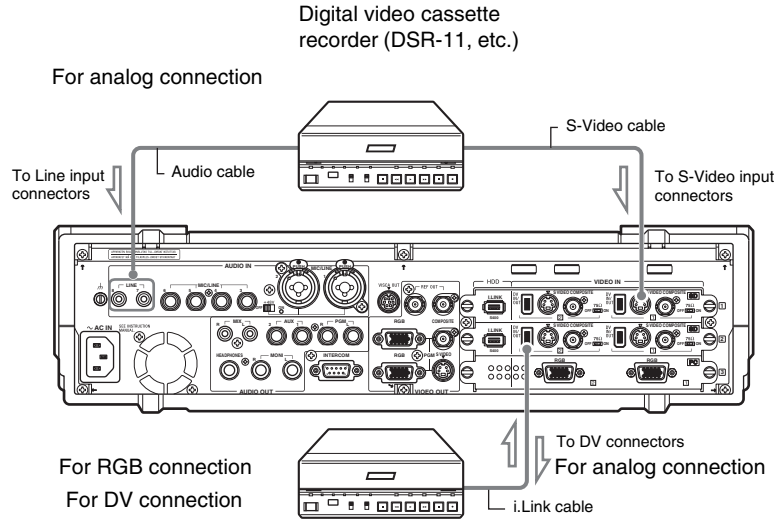

Note

i.LINK cables between 80 cm and 3.5 m (2.5 to 11.5 ft) are recommended.

Caution

- If when connected to another DV device the video or audio is not output, or there is noise, reconnect the cable, or power the DV device or this unit off and on again. This may solve the problem.
- It is not possible to connect more than one VCR to a single DV connector.

Connecting an External Hard Disk

For information about external hard disks, visit the following Anycast Station portal site:

<https://www.ecspert.sony.biz/ecsite/>

<https://servicesplus.us.sony.biz/SoftwarePlusSearch.aspx> (for the customers in the U.S.A.)

<https://www.sonybiz.net/anycast> (for the customers in Europe)

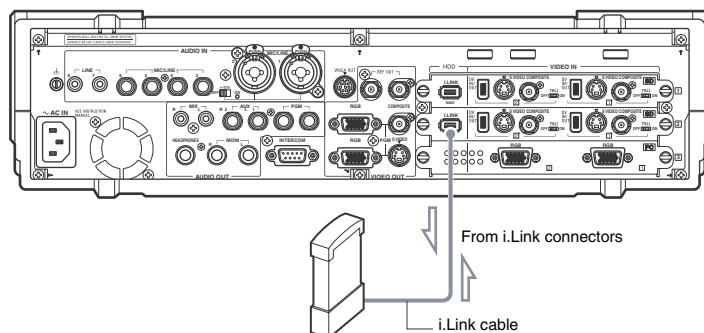

Caution

- If using a hard disk with a standby function, make sure that the standby function is disabled before connecting to this unit.
- Power on the connected hard disk before powering on this unit.
- Connect the i.LINK connector directly to the hard disk.
- It is not possible to connect more than one hard disk to a single i.LINK connector (daisy-chaining connection not possible).
- If you disconnect the i.LINK cable, or power off the hard disk without carrying out the necessary preparations for disconnecting the disk, then files may be corrupted, or the disk may need to be recovered. For details of unmounting, see “Operations on Files on the External Hard Disk” (page 134).

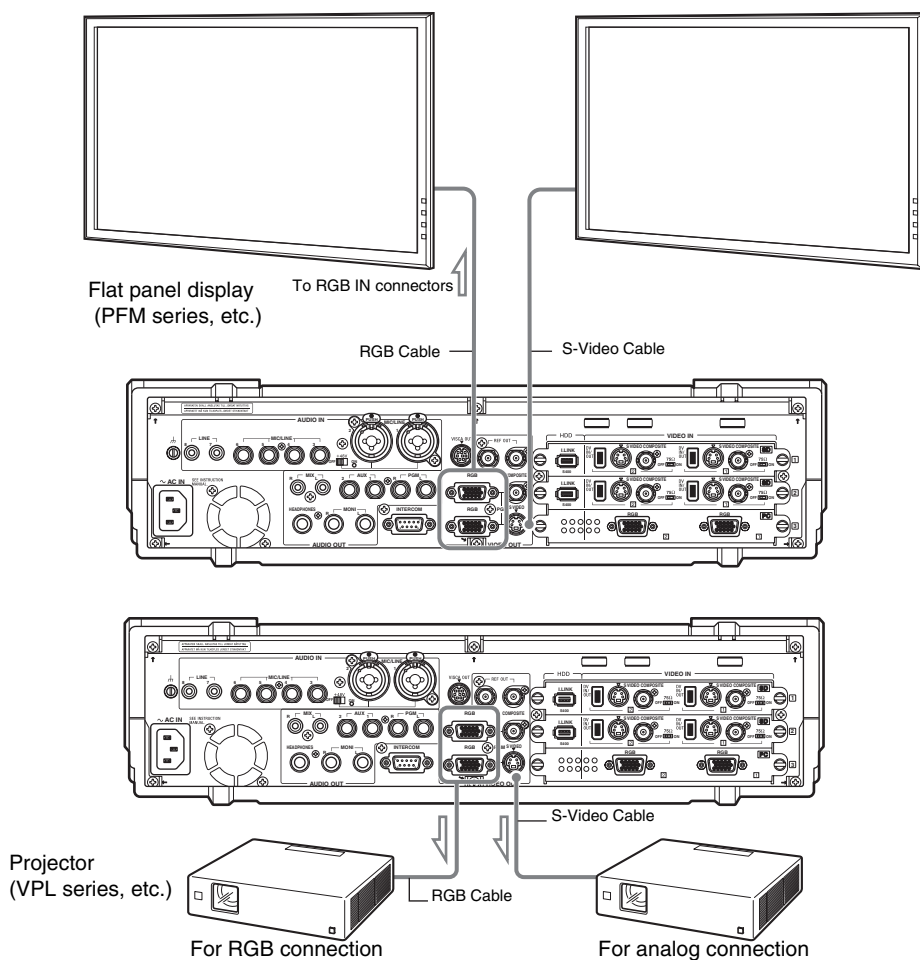
Connecting a Plasma Display/Projector**Notes**

- For more information on setting the resolution/clock phase and format, refer to “Setting the RGB Output Signal Format” (page 148)
- To reduce the effects of external noise, use a cable with an attached ferrite core.

Connecting an Amplifier

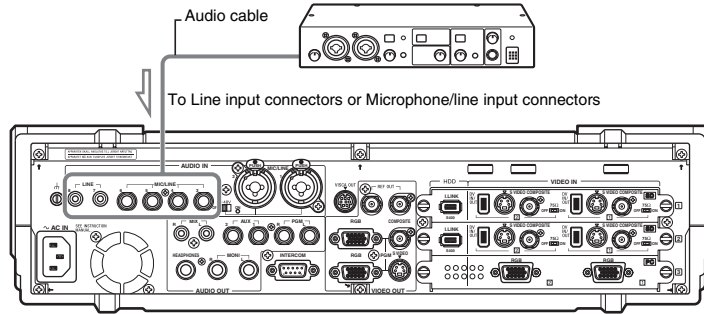

Preventing Accidental Cable Disconnection

Use the cable clip as necessary to secure cables and prevent accidental disconnection.

- 1 Using a flat head screwdriver, open the lever compartment as illustrated below.

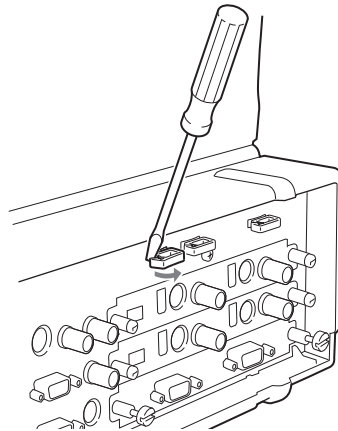

- 2 Pass the cables through the cable clip. Allow some slack when routing the cables to prevent them from bending sharply.
- 3 Close the lever compartment.

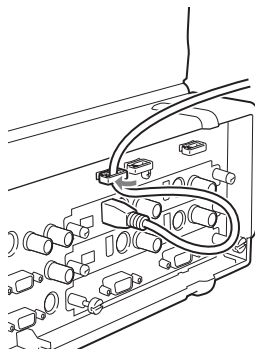



Installing Option Boards

The following option boards are available for this unit.

- BKAW-550
PC video interface module
- BKAW-570
SD video interface module

To install an option board, first remove the interface module fitted to the unit as standard, and install the new interface in the slot.

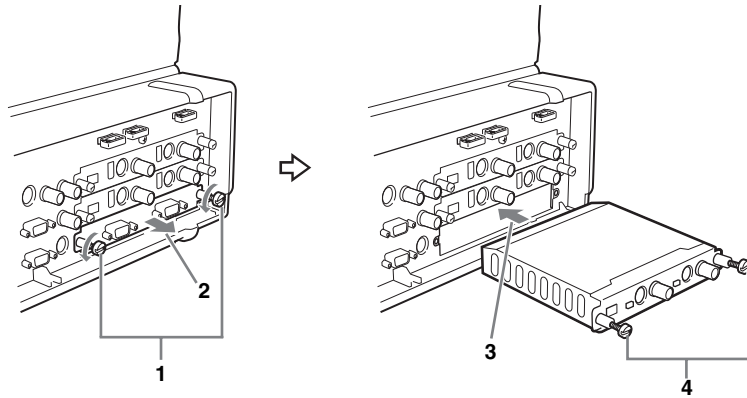

- 1** Loosen the two screws fixing the interface module fitted as standard.
- 2** Pull out the interface module.
- 3** Insert the option board into the slot.
- 4** Tighten the screws.

Caution

When installing an option board, always turn the unit off first. If you install an option board with the unit powered on, this may damage the option board.

Settings Related to Input Signals

These settings allow video and audio signals input from devices connected to the unit to be handled within the unit.

Relation Between Input Signals and System Components

You can assign input video and audio signals to buttons on the front panel and channel faders, then operate these to carry out switching, mixing, and combining. The operation screen continuously displays information about the video and audio input to this unit, and the video and audio program output. The following figure shows the relation between the input signals and system components, and the display on the operation screen.

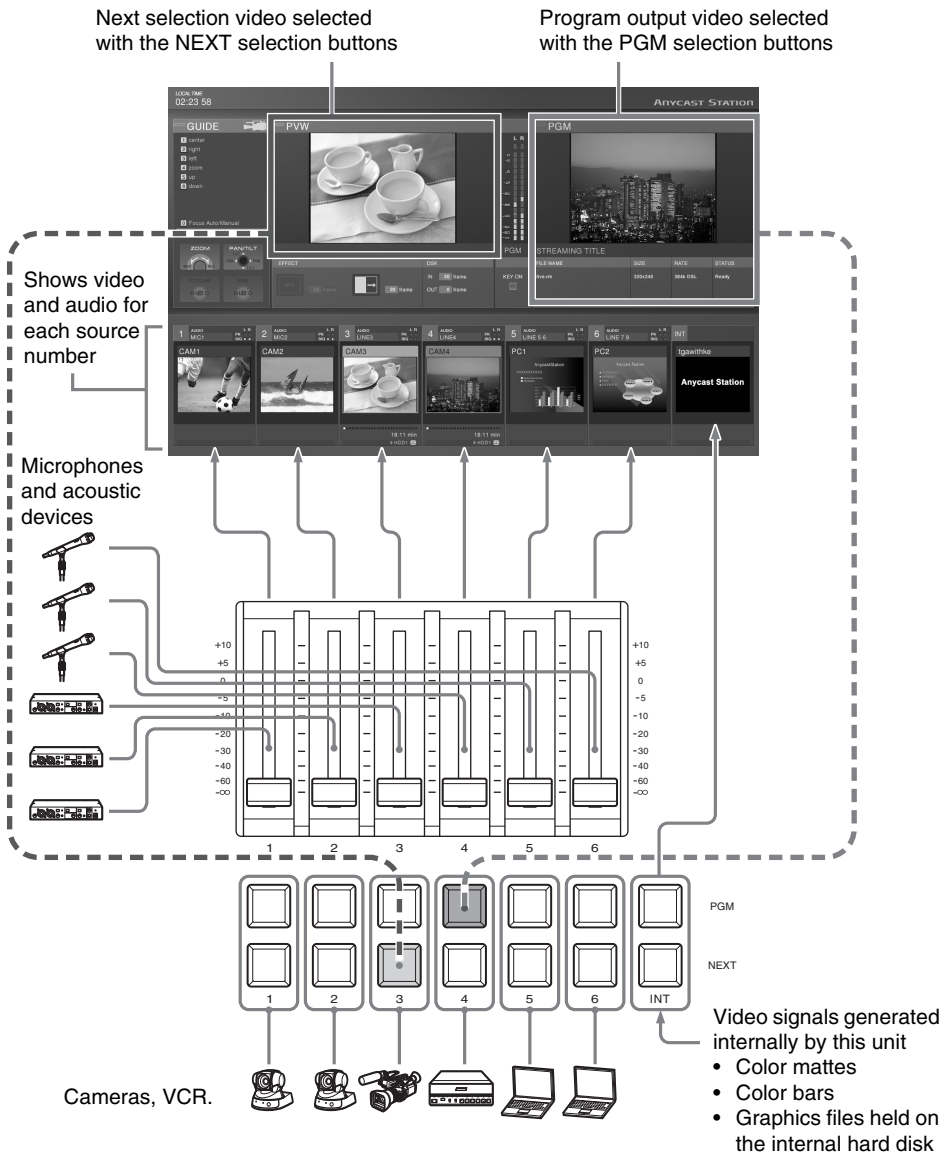

Video Signal Related Settings

These are preparations for handling video signals or the unit.

Assigning video input signals to the selection buttons

Assign video signals to the selection buttons 1 - 6 (PGM selection and NEXT selection buttons).

- 1 Press the MENU button.
- 2 In the top menu, select [Video Input Assign].
- 3 From the list select the number of the selection button, and confirm, then set the following items in the submenu.

Assigning a name for the video

Assign a name for the video. The name assigned here appears in the source viewer with the same number as the selection button.

- ① Select [Source Name], and confirm; ② enter the name in the input box, and confirm.

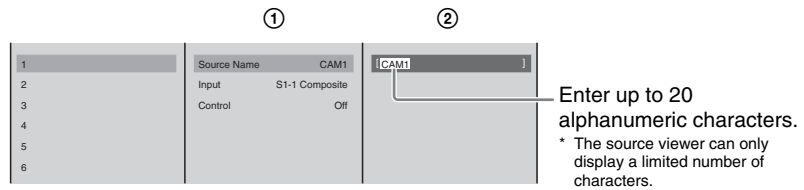

Specifying a video input connector

Specify the video input to be assigned to the selection button is input.

- ① Select [Input], and confirm; ② select the video input connector from the list, and confirm.

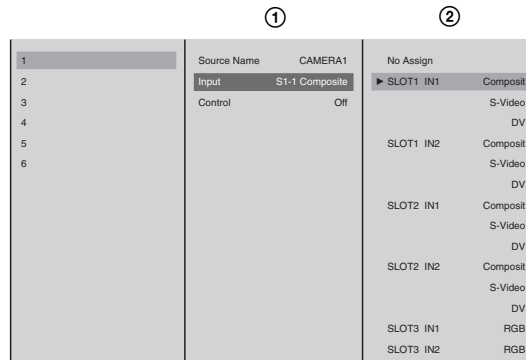

Caution

- You can only use one of the following from the same video input on the same interface module: Composite (Composite video input connector), S-Video (S-Video input connector), or DV (DV connector).
- It is not possible to assign more than one selection button to a single video input connector. If you attempt to assign to a different selection button a video input connector which has already been assigned to a selection button, a confirmation message appears. If you then select [OK], the

assignment switches to the new selection button, and the material viewer for the originally assigned selection button shows the indication [No Input Assign].

- **About the DV signal lock time**

When DV is selected for the input video, there is a delay until the DV signal locks and the video appears.

Notes

- The items in the list depend on the interface module installed in this unit.
- For details of [Control] in the menu ①, refer to “Registering Cameras to be Controlled” (page 121).

4 If required, repeat step 3 similarly for the remaining selection buttons.

5 Press the MENU button to close the menu.

Audio Signal Related Settings

These are preparations for handling audio signals on the unit.

Assigning audio input signals to channel faders

Assign the audio signals input to the audio input connectors on the rear panel to channel faders 1 to 6.

If you assign different audio signals to the left and right channels (L/R) of the channel faders, they become binaural faders, and if you assign the same audio signal to both channels, they become monaural faders.

1 Press the MENU button.

2 In the top menu, select [Audio Input Assign].

3 Select the channel fader number from the list, and confirm, then set the following items in the submenu.

Assigning a name

Assign a name to the audio signal. The name assigned here appears in the source viewer with the same number as the channel fader.

① Select [Source Name], and confirm; ② enter the name in the input box, and confirm.

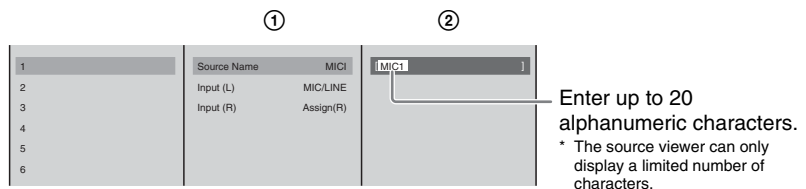

Specifying an audio input connector

Specify the audio signal to be assigned to the channel fader. For stereo audio, specify the source for each of the left and right channels separately.

For monaural audio, specify the same input for both left and right channels.

① Select [Input (L)], and confirm; ② select the audio input connector from the list, and confirm.

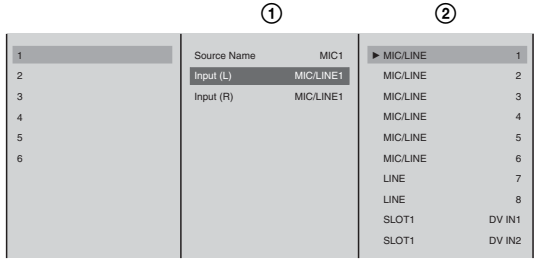

Note

If in [Input (L)] you select the DV input connector, the same input connector is automatically assigned to [Input (R)].

Caution

- For DV input, it is not possible to assign more than one selection button to a single DV input connector. If you attempt to assign to a different selection button a DV input connector which has already been assigned to a selection button, a confirmation message appears. If you then select [OK], the assignment switches to the new selection button, and the originally assigned selection button returns to the default setting.
- **About the DV signal locking time**
When DV is selected for the input audio, there is a delay until the DV signal locks and the audio can be heard.

Similarly, select [Input (R)], and confirm; select the audio input connector from the list, and confirm.
When the input audio signal reaches the reference level, the input signal indication in the source viewer lights green and you can confirm that there is an audio input.

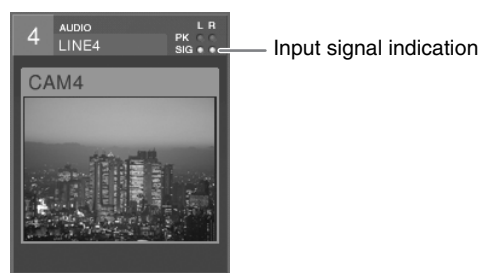

4 Press the MENU button to close the menu.

Setting the MIC/LINE level of an audio input

If the peak indication appears (when set to the default MIC/LINE level of “Middle (-20 dB)”)

If the input audio signal is too loud, the peak indication in the source viewer lights red.
In this case, since the MIC/LINE level exceeds the standard input level, use the following procedure to adjust it.



Example: When the peak indication has lit with MIC/LINE 2 connected to R and MIC/LINE 1 connected to L, as illustrated below.

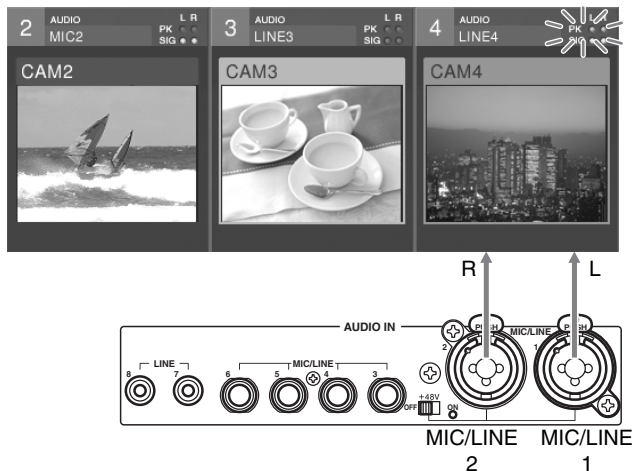

- 1 Press the MENU button.
- 2 In the top menu select [Audio MIC/LINE Level].
- 3 ① Select the number of the MIC/LINE input connector to which is connected the target audio signal, and confirm; ② select [High(+4dB)], and confirm.
In this example, both [MIC/LINE 1] and [MIC/LINE 2] are set to [High (+4dB)].

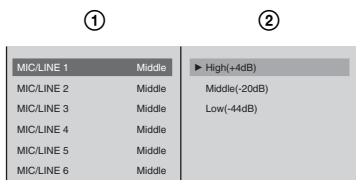

- 4 Press the MENU button to close the menu.

If no input signal indication appears (when set to the default microphone/line level of “Middle (-20 dB)”)

If no input signal indication appears in the source viewer even though an audio signal is input, the microphone/line level is not reaching the reference level. Using the same procedure as detailed in “If the peak indication appears” above, select the number of the microphone/line input connector, and at step 3-②, select [LOW (-44dB)], and confirm.



Relation Between Program Output Display and Input and Output Formats

Depending on the format and resolution of the input signal, the size and cropping of the output video is as follows.

Material with a 4:3 aspect ratio

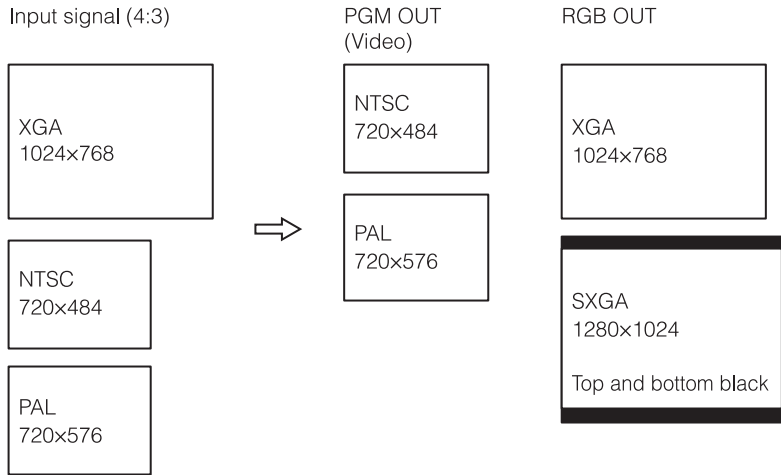

Material with a 5:4 aspect ratio

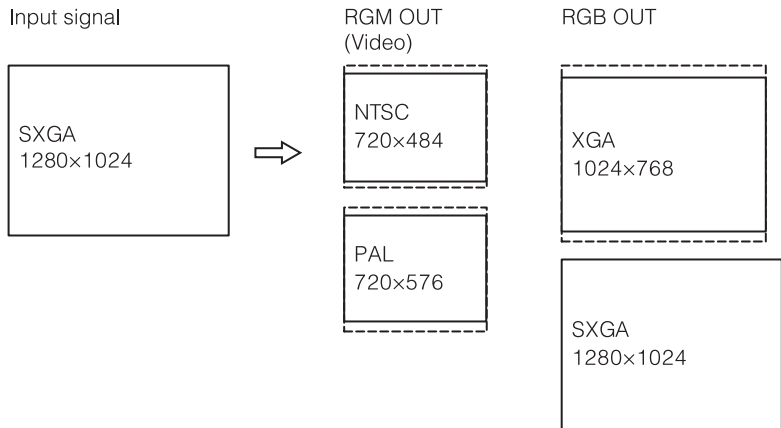



Video Switching

This section describes how to switch the video signals input to the unit, and output the final video (output program) from the PGM output connectors. With this unit, you can also apply some video effects.

Note

First, make the settings described in “Video Signal Related Settings” (page 53).

Basics of Video Switching

This section describes only the most basic switching operations. See the relevant sections for details of switching and effect operations.

Cut switching

This is the most basic and commonly used type of switching. The video changes instantaneously from A to B.

For details, refer to “Changing the Video with a Cut” (page 60).

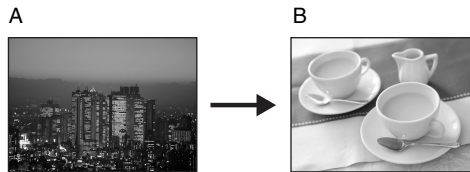

Switching with a transition effect

In a transition effect, the image gradually switches from one video to another through the application of one of various effects.

For details, refer to “Changing the Video with a Effect Transition” (page 62).

Changing the Video with a Cut

This switches the video instantaneously, with no added effects. This is the most basic form of switching.

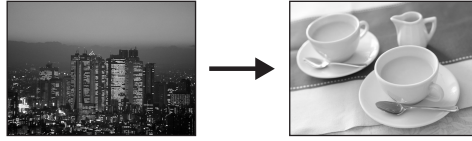

Basic operation for a video cut

There are two methods of making a cut, as follows.

- Switching directly by pressing a PGM selection button
 - Checking the next video in the PVW viewer, then pressing the CUT button
- The following diagram shows the flow of operations in carrying out a video cut.

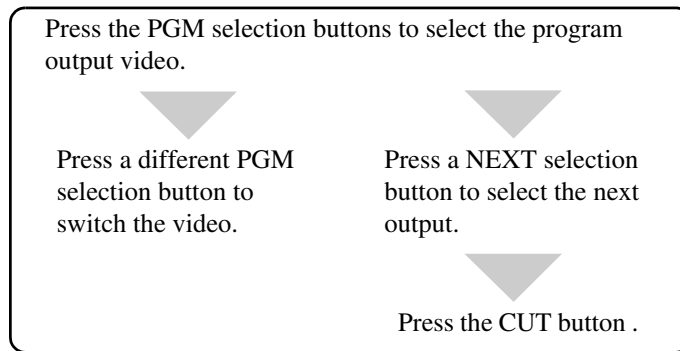

Switching directly by pressing a PGM selection button

To switch from one video to another, you can simply press the PGM selection button to which the new video is assigned.

- 1 In the source viewer, select the video for program output.



Example: You may select video 4.

- 2 Press the PGM selection button with the same number as the selected video.

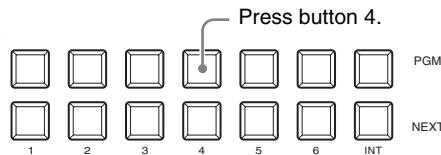

The PGM selection button you pressed lights red, and the selected video appears in the PGM viewer.

The same video as shown in the PGM viewer is now output from the PGM output connectors.



A red frame appears around the source viewer for the selected video.

- 3 Determine on the next video, then repeat the procedure in step 2.

Switching with the CUT button after checking the next video in the PVW viewer

To switch while checking the new video in the PVW viewer, use the CUT button.

- 1 In the source viewer, select the video you want to switch to (the next program output).



Example: You may want to switch to video 3. Current program output video

- 2 Press the NEXT selection button with the same number as this video.

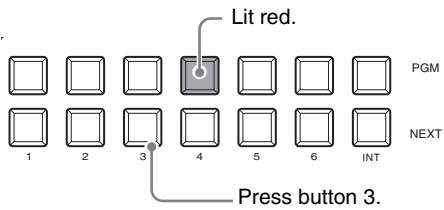

The NEXT selection button you pressed lights amber, and the selected video appears in the PVW viewer.



An amber frame appears around the source viewer for the next video.

3 Press the CUT button.

This interchanges the video in the PGM viewer and PVW viewer, and switches the program output video.

At the same time, the lit PGM selection button and NEXT selection button interchange, and the colors of the frames in the source viewer also interchange.

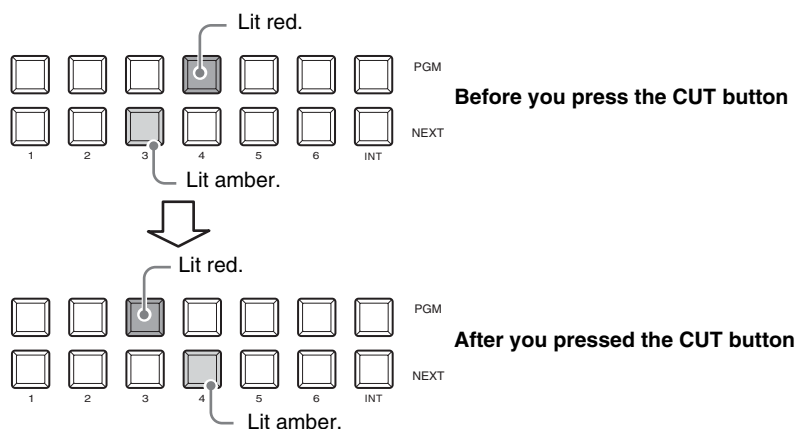

Each press of the CUT button interchanges the program output video and the NEXT selection video.

Changing the Video with a Effect Transition

Instead of an instantaneous cut, you can gradually switch from one video to another through the application of one of various effects.

Basic transition effect operations

The basic procedure for applying an effect to a transition is as follows.

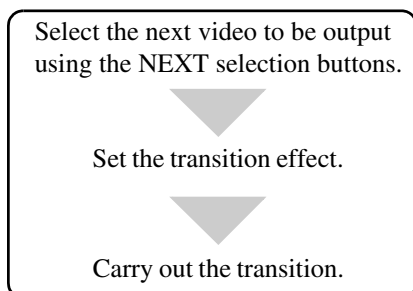

There are two ways of executing a transition:

- Automatic execution with the AUTO TRANS button
- Manual execution using the transition lever

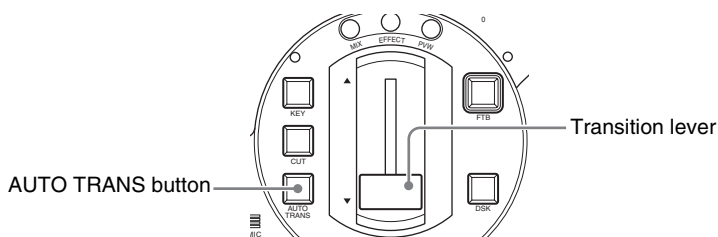

AUTO TRANS button

Pressing the AUTO TRANS button carries out the transition automatically, using the preset transition time.

Transition lever

Moving the transition lever in the direction shown by the LED indicators (Δ ∇) progresses the transition in sync with the lever movement.

Switching with a dissolve

In a dissolve, one video image fades into another.



Basic operation for a dissolve

The basic procedure for a dissolve is as follows.

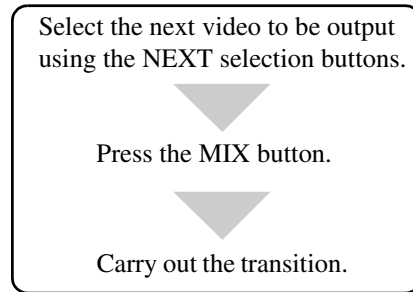

- 1 Determine the next program output video, and select this with the NEXT selection button.

The selected video appears in the PVW viewer.

- 2 Press the MIX button.

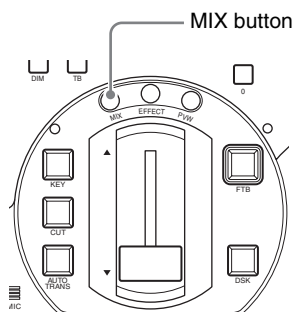

The MIX button lights amber, and the effect indication on the operation screen shows the current mix state (progress of the dissolve).



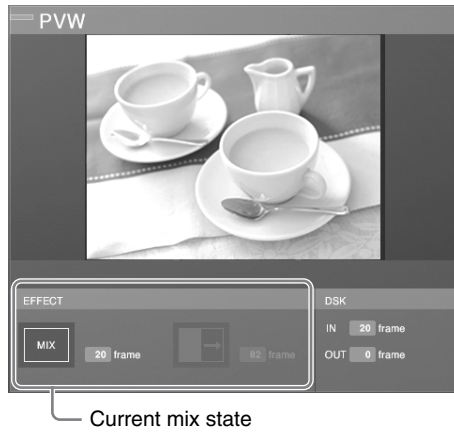

Notes

- The mix state shows the current transition time setting.
- You can still change the transition time at this point. To change the setting, follow the procedure in “Changing the Transition Time” (page 66).

3 Carry out the transition with the AUTO TRANS button or transition lever. The NEXT selection video dissolves into the program output video.



Each press of the AUTO TRANS button, or operation of the transition lever, carries out a dissolve transition from the program output video to the NEXT selection video.

Switching with a wipe

In a wipe, two video images occupy the display simultaneously, with the area occupied by one growing until it wipes out the other. You can choose from sixteen different wipe patterns.



Basic operation for a wipe transition

The basic procedure for a wipe transition is as follows.

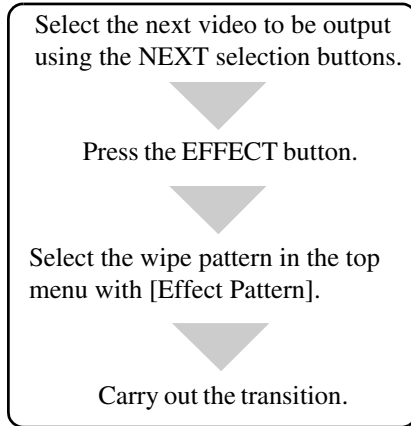

- 1 Determine the next program output video, and select this with the NEXT selection button.

The selected video appears in the PVW viewer.

- 2 Press the EFFECT button.

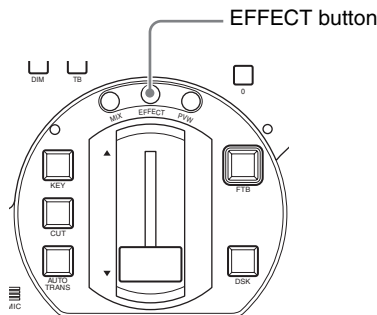

The EFFECT button lights amber, and the effect indication shows the current effect state.

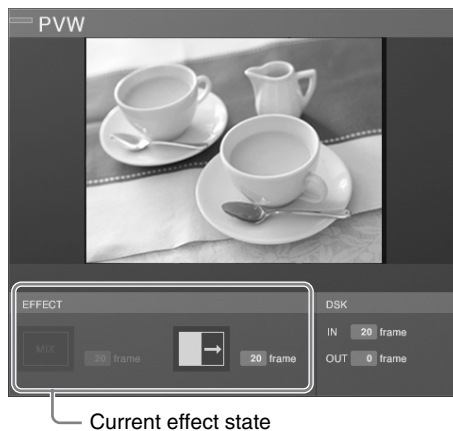

Notes

- The current effect state shows the transition time and effect pattern settings.

- You can change the transition time. To change the setting, follow the procedure in “Changing the Transition Time” (page 66).
- You can change the effect pattern. To change the setting, follow the procedure in “Changing the Effect Pattern” (page 67).

3 Carry out the transition with the AUTO TRANS button or transition lever. The program output video changes to the NEXT selection video by a wipe transition.



Each press of the AUTO TRANS button, or operation of the transition lever, the program output video changes to the NEXT selection video by a wipe transition.

Note

It is also possible to apply an edge effect to the wipe pattern. For details, refer to “Applying Edge Effects” (page 79).

Changing the Transition Time

Before carrying out a transition with the AUTO TRANS button, set the transition time.

- 1** Press the MIX button or EFFECT button.
The current settings appear in the effect display.
- 2** Press the MENU button.
- 3** In the top menu, select [Video Effect].
- 4** ① Select [Transition Time], and confirm; ② move the slider to set the transition time.

The transition time is set in frame units.

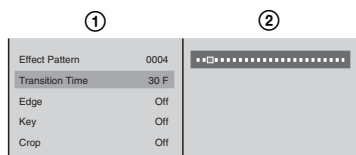

- 5** Press the MENU button to close the menu.
The set transition time appears in the effect display.

Changing the Effect Pattern

- 1 Press the EFFECT button.
The current settings appear in the effect display.

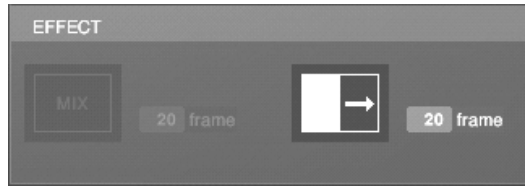

Note

Here you can also press the EFFECT button once more to recall the [Effect Pattern] menu, and skip from step 2 below as far as ① within step 4.

- 2 Press the MENU button.
- 3 In the top menu, select [Video Effect].
- 4 ① Select [Effect Pattern], and confirm; ② select the wipe pattern from the list, and confirm.

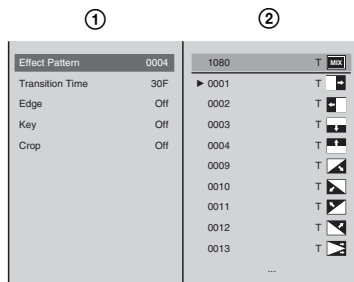

- 5 Press the MENU button to close the menu.
The selected effect pattern appears in the effect display.

Using Fade-to-Black (FTB)

This fades the video in from or out to a black screen.

Press the FTB button.

This fades out the program output to a black screen, except for any superimposed logo.

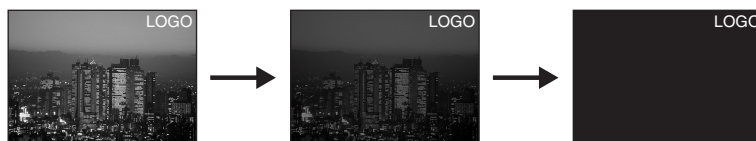

Press the FTB button once more to fade in the video from the black screen.

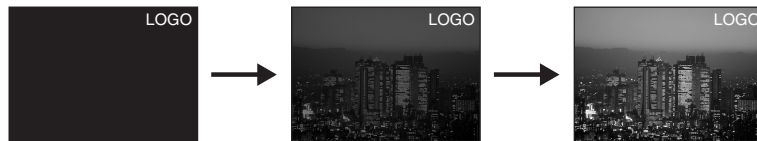

Note

While the screen is black, the PGM selection buttons change to amber.

Fading in a different video after fading out

- 1 After fading to a black screen, select a different video with the PGM selection buttons.
- 2 Press the FTB button.
This fades in the newly selected video.

Setting the Fade to Black transition time

- 1 Press the MENU button.
- 2 In the top menu, select [Fade To Black].
- 3 ① Select [Transition Time], and confirm; ② move the slider to set the transition time.



- 4 Press the MENU button to close the menu.

Using Color Bars and Color Mattes

The Internal Color Bar is provided for adjustment and test transmission. The Internal Color Matte is provided for a background.

- 1 Select the internal (INT) source using the NEXT buttons.
The INT source selection menu appears in the menu display.
- 2 Select the color bars or color matte you want to show, and confirm.

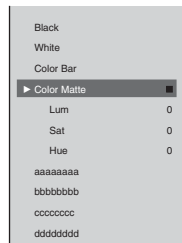

Note

This unit can output the following 2 color bars for each video output signal format setting.

- With NTSC: SMPTE color bar (75%)
- With PAL: EBU color bar (100%)

The selected internal video signal appears in the “INT” source viewer.

Note

You can change the color of the color matte. For details, refer to “Adjusting Color Matte” (page 147).

Using the Downstream Key (DSK) Function to Add Text or an Image

You can add text or an image to video that already includes an effect or combination.

This is useful for adding subtitles, for example.

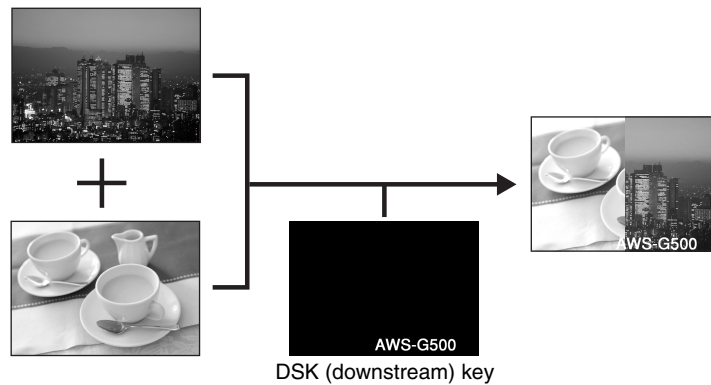

Basic downstream key operations

The basic procedure for downstream keying is as follows.

Select the image to be impated.

▼

Select a graphics file from the INT source selection menu.

▼

Press the DSK button to insert the key.

Inserting a downstream key

In order to use a downstream key for text or graphics, it must first be imported onto the internal hard disk of this unit. You can use the alpha channel of a graphics file in targa format as the key source, which allows high-quality downstream keying.

For details on importing a graphics file, refer to “Importing Graphics Files” (page 156).

- 1 Press INT in the NEXT selection buttons.
The INT source selection menu appears.
- 2 Use the jog roller to select a graphics file displayed in the lower part of the INT source selection menu, and confirm.

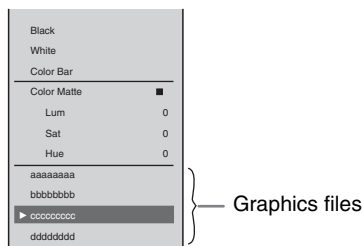

The selected graphics file appears in the “INT” source viewer.



Note

While the graphics file is being read in, the message “Loading...” appears at the bottom of the PVW viewer and in the device status in the source viewer.

- 3 Press the DSK button.
DSK button lights red, and the graphics file image appears in the PGM viewer.



If you press the DSK button once more, the inserted image is removed. Each press of the DSK button alternately inserts or removes the image.

Note

If you change the video to a black screen using FTB, no downstream key is output. In this case, the DSK button lights amber.

Setting the downstream key transition times

You can set the DSK transition times which are the times taken for the text or image to be gradually inserted, or to be gradually removed. These are set in frame units.

- 1 Press the MENU button.
- 2 In the top menu, select [DSK].

- 3 ① Select [On Trans. Time], and confirm; ② move the slider to set the time until the image appears.

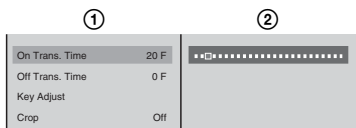

- 4 ① Select [Off Trans. Time], and confirm; ② move the slider to set the time to disappear.

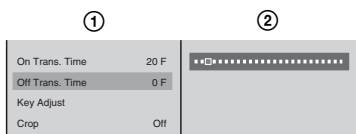

- 5 Press the MENU button to close the menu.

The DSK transition time setting appears in the DSK display of the effect display in the operation screen.



Adjusting the downstream key

You can adjust the parameters for inserting text or image, or crop unwanted portions.

- 1 Press the DSK button to insert the image.
- 2 Press the MENU button.
- 3 In the top menu, select [DSK].
- 4 In the submenu, set the following adjustment items.

Adjusting the outline of the text or image

- ① Select [Key Adjust], and confirm; ② select the item to adjust, and confirm; ③ adjust the sliders.

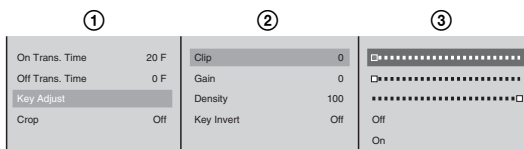

The items you can adjust are as follows.

[Clip]: Adjusts the threshold level for keying.

[Gain]: Adjusts the sharpness of the key outline.

[Density]: Adjusts the density of the text or image to be inserted.

Note

If you have recalled and adjusted a graphics file, the adjusted values of the graphics file change as follows depending on the next file recalled:

- When a file with no alpha channel is recalled: adjusted values remain unchanged.
- When a file with an alpha channel is recalled: values return to their default settings.

Inverting the key

By inverting the key, you can use an image of black lettering on a white background as the key.

- ① Select [Key Adjust], and confirm;
- ② select [Key Invert], and confirm;
- ③ select [On], and confirm.

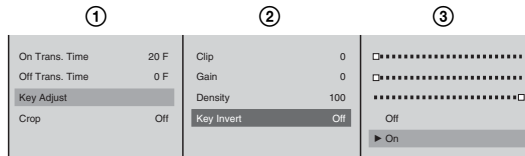

Cropping unwanted portions of the text or image

- ① Select [Crop], and confirm;
- ② select [On], and confirm;
- ③ select the side (top, bottom, left, or right) to be displayed, and confirm;
- ④ move the slider to crop.

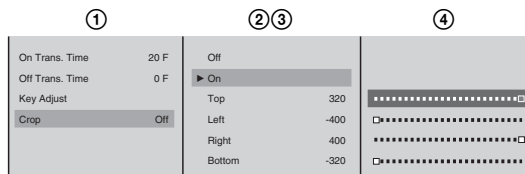

- 5 Press the MENU button to close the menu.

Showing a Logo on the Screen

For copyright protection purposes, you can superimpose a logo (160×120 pixel graphic) on the video.

When the logo is enabled, the logo is superimposed on the program output video.



Basic operation for showing a logo

The basic procedure for showing a logo is as follows.

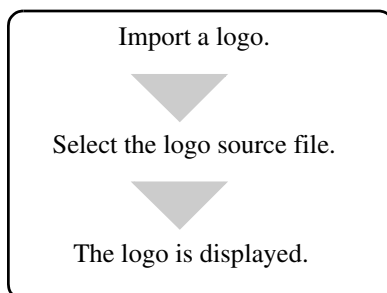

Showing a logo in the video

To show a logo, first it is necessary to import the logo file to the internal hard disk of this unit.

For details on importing a logo file, refer to “Importing Logo Files” (page 157).

- 1 Press the MENU button.
- 2 In the top menu, select [Logo].
- 3 ① Select [Logo Source], and confirm; ② select the logo file from the list, and confirm.



The image is inserted in both the PGM viewer and PVW viewer.

Note

By selecting a logo file from the list, it always appears in the program output video. If you do not want to show the logo, select [None].

- 4 Press the MENU button to close the menu.

Adjusting the logo display

Adjust the parameters for logo insertion, and set the logo position.

- 1 Show the logo.
For details of the operation, refer to “Showing a logo in the video” (page 73).
- 2 Press the MENU button.
- 3 In the top menu, select [Logo].
- 4 In the submenu, set the following adjustment items.

Adjusting the outline of the logo

- ① Select one of [Clip], [Gain], and [Density], and confirm; ② adjust the slider.

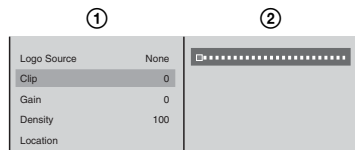

The items you can adjust are as follows.

[Clip]: Adjusts the threshold level for the logo key.

[Gain]: Adjusts the sharpness of the outline.

[Density]: Adjusts the density of the text to be inserted.

Note

When you have recalled a logo file and made adjustments, the logo file adjustment values for the logo file depend on the next recalled file as follows:

- When a file with no alpha channel is recalled: the adjustments are maintained as is.
- When a file with an alpha channel is recalled: the adjustments are returned to their default values.

Specifying the position of the logo display

① Select [Location], and confirm; ② select [X] or [Y], and confirm; ③ specify the position with the sliders.

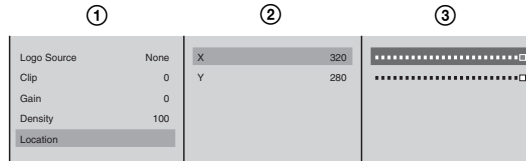

The meaning of these items are as follows.

[X]: Specifies the horizontal position.

[Y]: Specifies the vertical position.

5 Press the MENU button to close the menu.

Using Luminance Keying

Video A and video B images are combined by comparing the components of brightness (luminance) to cut unneeded portions of the video B image. Generally, bright lettering is drawn on a black background, and this is used as the key.

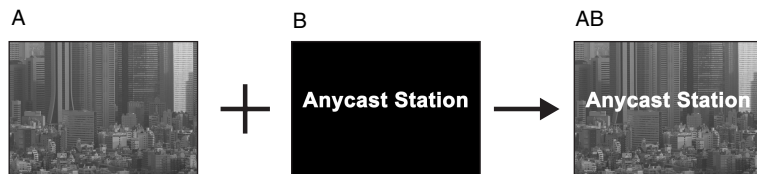

Note

Pressing the KEY button switches to key mode (the KEY button, NEXT selection buttons, MIX button and EFFECT button light green, and the AUTO TRANS button, CUT button, and transition lever now apply a keying operation).

Basic operation for luminance keying

The basic procedure for luminance keying is as follows.

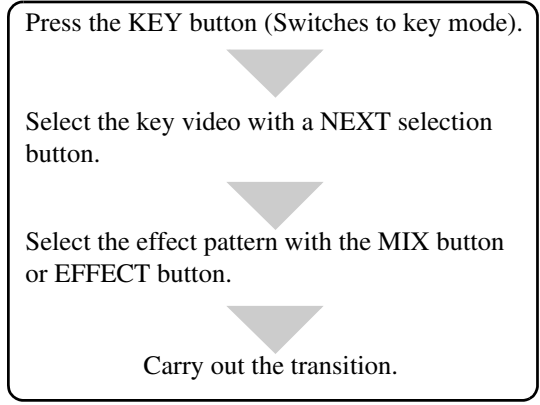

- 1 Press the KEY button.
The KEY button, NEXT selection buttons, and MIX button or EFFECT button light green and are now used for keying video.
- 2 Select the video for keying with the NEXT selection button.
A green frame appears around the selected video in the source viewer.

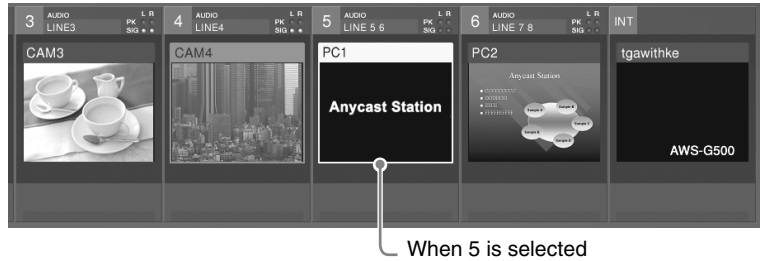

- 3 Press the MIX button or EFFECT button.
The button green, and the details of the current effect appear in the effect display.

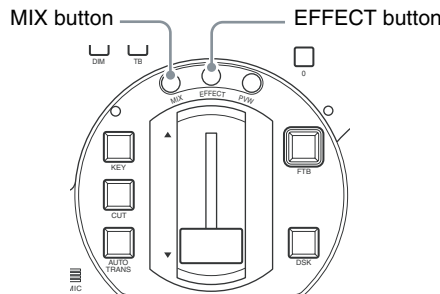

Notes

- You can change the transition time. To make this change, use the procedure in “Changing the Transition Time” (page 66).
- You can change the effect pattern. To make this change, use the procedure in “Changing the Effect Pattern” (page 67).

- In key mode, you can maintain the transition time, effect pattern, and edge adjustments for keying.

4 Apply the video effect using the AUTO TRANS button, CUT button, or transition lever.

This keys the NEXT selection into the program output video.



The [KEY ON] indicator on the operation screen lights red.



Press the AUTO TRANS button or CUT button once more, or operate of the transition lever in the opposite direction, to remove the combined video effect.

The [KEY ON] indicator on the operation screen also turns off.

Each press of the AUTO TRANS button or CUT button or operation of the transition level alternately inserts or removes the video effect.

Previewing Keying Results (effect preview)

You can preview the results of keying in the PVW viewer, before switching to program output.

Note

Press the PVW button to switch to PVW mode (in which the PVW viewer is used for effect preview).

Basic operation for previewing in the PVW viewer

The general sequence of operations in the PVW viewer is as follows.

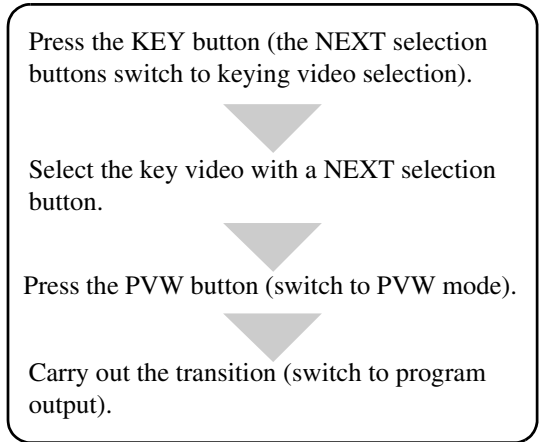

- 1** Press the KEY button.
The KEY button, NEXT selection buttons, and MIX or EFFECT button light green, and are now used for keying video.
- 2** Press the NEXT selection button assigned to the video to be combined.
A green border appears around the selected video in the material viewer, and the video appears in the PVW viewer.



- 3** Press the PVW button, to switch to PVW mode.
The PVW button lights orange, and a preview of the combined result appears in the PVW viewer.



Check the combined result, use the following operation to switch to program output.

- 4** With the AUTO TRANS button, CUT button, or transition lever, carry out the keying.
The combined result is sent to program output, and appears in the PGM viewer.

The preview in the PVW viewer disappears (changes to the result of the next transition).



- 5 Press the PVW button, to end PVW mode.

The PVW viewer returns to the video selected from the NEXT selection buttons.

Adjusting the Combined Video

- 1 Perform keying.
- 2 Press the MENU button.
- 3 In the top menu, select [Video Effect].
- 4 Select [Key], and confirm, then make the following settings in the submenu.

Sharpening the outline of the key

- ① Select one of [Clip], [Gain], and [Density], and confirm; ② adjust the slider.

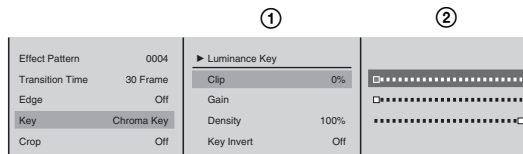

The meaning of these items are as follows.

[Clip]: Adjusts the threshold for background cutout.

[Gain]: Adjusts the sharpness of the outline.

[Density]: Adjust the density of the video to be combined.

Note

If you have recalled and adjusted a graphics file, the adjusted values of the graphics file change as follows depending on the next file recalled:

- When a file with no alpha channel is recalled: adjusted values remain unchanged.
- When a file with an alpha channel is recalled: values return to their default settings.

Inverting the luminance key

① Select [Key Invert], and confirm; ② select [On], and confirm.

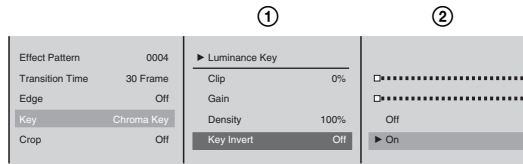

5 Press the MENU button to close the menu.

Cropping Unwanted Portions From the Video Being Combined

- 1 Carry out a keying effect.
- 2 Press the MENU button.
- 3 In the top menu, select [Video Effect].
- 4 ① Select [Crop], and confirm; ② select [On], and confirm; ③ select the side (top, bottom, left, or right) to crop, and confirm; ④ move the slider to crop.

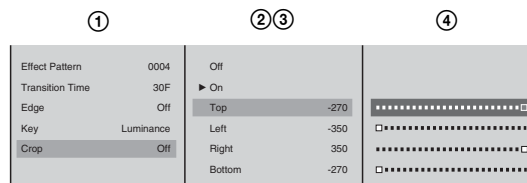

5 Press the MENU button to close the menu.

Applying Edge Effects

It is possible to apply edge effects when using a wipe effect.

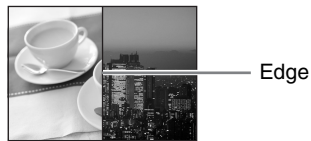

For a wipe

- 1 First set the effect pattern.
- 2 Press the MENU button.
- 3 In the top menu, select [Video Effect].

- 4 ① Select [Edge], and confirm; ② select [On], and confirm; ③ select the item to be set, and confirm; ④ adjust the slider.

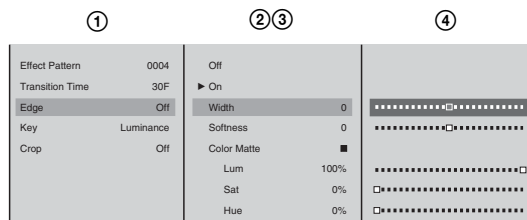

The meaning of these items are as follows.

[Width]: Adjusts the width of the border.

[Softness]: Adjusts the blurriness of the edge.

[Color Matte]: Changes the color of the border. Select [Lum] (luminance), [Sat] (saturation), or [Hue], and adjust the slider.



Creating a Title Graphic with the Text Typing Tool

Features of the Text Typing Tool Software

The text typing tool software is an application for creating simple titles. You can switch between the Anycast Station main software (the main software) and this application as you proceed.

- A file created with the text typing tool software is simultaneously saved in the Anycast Station main software, and can be used as a DSK (downstream key) or luminance key source.

Text typing tool software

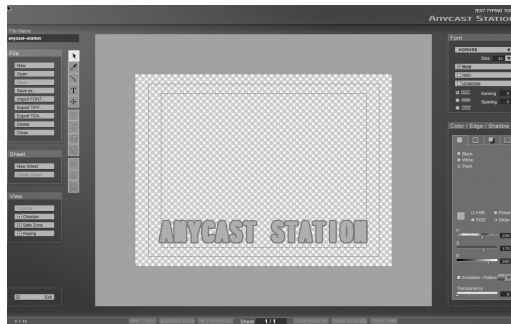

Anycast Station main software

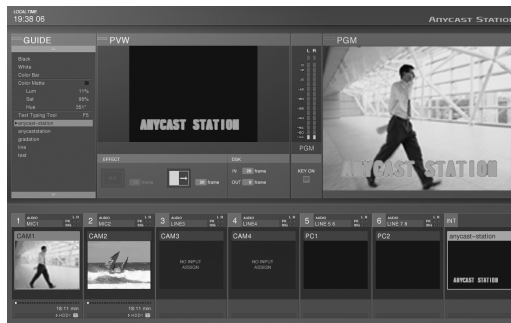

- By capturing one scene of the program output video and showing it as a background, you can get an impression of the final result of superimposing of the key, and position objects (characters and lines) accurately.

Sheets and files

In the text typing tool software, you create one title as a single sheet.

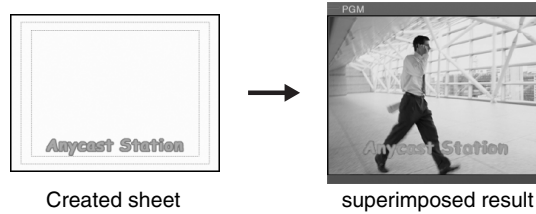

You can save multiple related sheets (for example, for a single program) together in a file.

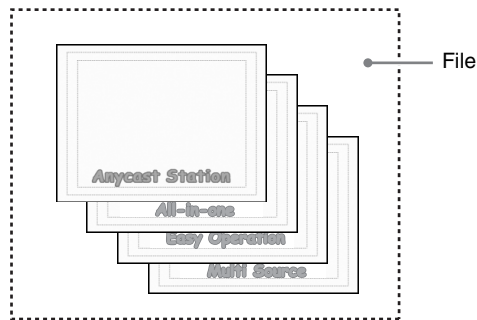

When creating similar title, you can copy a object to create the sheet, and therefore eliminate the trouble of creating a new file from scratch.

Flow of Operations

To use the text typing tool software, it is first necessary to upgrade the operating software (When the software version you are using is 1.00.).

For details of how to upgrade, see the section "Upgrading the Operating Software" (page 176) in the Live Content Producer Operating Instructions.

- 1** Press the  (power) button on the side panel.
The operation screen appears.
- 2** Press the keyboard F5 (Fn+5) key.
You can work by switching between the Anycast Station main software and the text typing tool software.

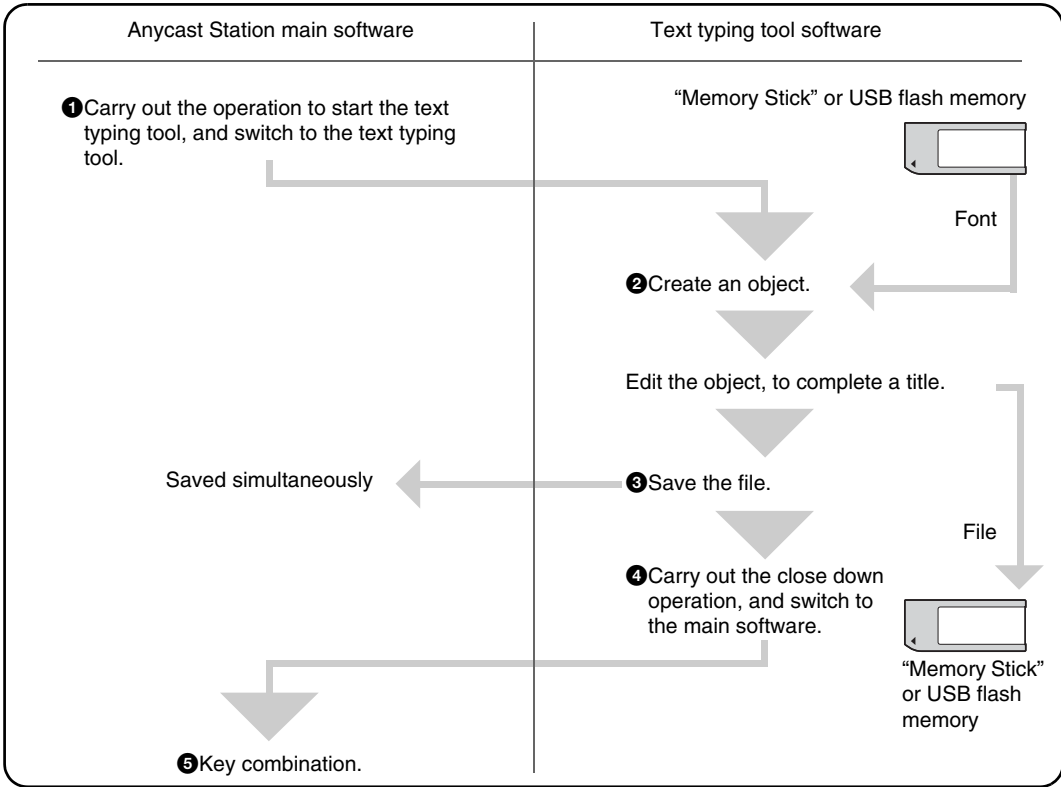

Note

With a “Memory Stick” or USB flash memory, you can import font files, and export created titles. You can use exported files on such as a computer.

Caution

- It is not possible to use a USB mouse with the Anycast Station main software.
- If the USB mouse does not respond in the text typing tool software, try disconnecting it and connecting to the other USB connector.

Starting Up

- 1 In the Anycast Station main software, press the “INT” NEXT selection button.
The INT material selection menu appears in the menu display.
- 2 Select [Text Typing Tool].

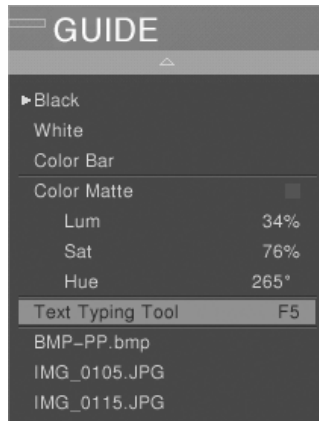

The following confirmation message appears.

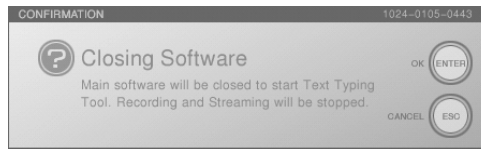

- 3 Press the ENTER button on the front panel.
The screen goes black and the text typing tool software starts.

Caution

- If you switch while using the Anycast Station main software, the image or sound may be distorted.
- If you switch while the Anycast Station main software is starting up, the system may not function correctly. Check that all viewers (PGM/PVW/ material) have started up before switching to the text typing tool software.

Note

You can also use the keyboard F5 (Fn+5) key to switch to the text typing tool software.

Closing Down

To power off the unit

Press the  power button on the side panel.
This closes the text typing tool software, and powers off.

Caution

If there is a file in the process of creation, the program will end without saving it.

To close the text typing tool software and start the Anycast Station main software

- 1 Click the [Exit] button at the lower left of the screen.

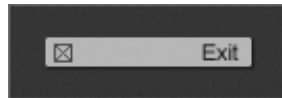

The screen goes black and the Anycast Station main software starts.

Note

You can also use the keyboard F5 (Fn+5) key to switch to the Anycast Station main software.

In this case, following confirmation message appears.

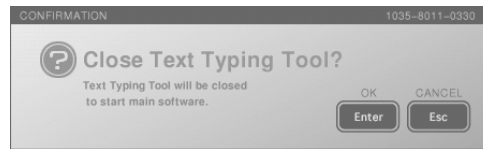

- 2 Click the [Enter].

Standard Operations

This section describes standard operations used as various points in the text typing tool software.

Mouse operations

- By connecting a USB mouse to the USB connector on the side panel, you can carry out mouse operations.
- You can also carry out mouse operations with the pointer of the supplied keyboard.

Standard button operations

Click a button to carry out its function.

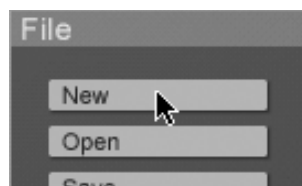

Standard checkbox operations

Click a checkbox to insert or remove the check mark. The function is active as long as a check mark is present.



Standard pull-down list operations

This section describes standard pull-down list operations. Click the ▼ button to display the pull-down list.



Standard keyboard operations

- The ↑ and ↓ keys move the focus (in reverse video) within the pull-down list.
- Press the Enter key to confirm the item which currently has the focus.
- Press the Fn+~` key (Esc) to cancel the selection, and close the pull-down list.

Standard operations for text input

The following are standard keyboard operations for text input.

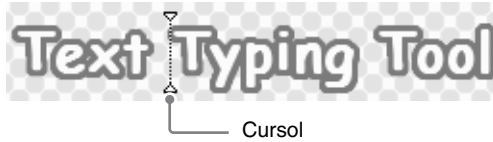

Key	Operation
←, →	Move the cursor horizontally one position at a time.
↑	Move the cursor up one position at a time.
↓	Move the cursor down one position at a time.
Shift + ←, Shift + →	Select one character at a time, horizontally from the cursor position.
Delete	When there is a character selection: delete the selection. When there is no character selection: delete the character following the cursor.
Backspace	When there is a character selection: delete the selection. When there is no character selection: delete the character before the cursor.
Enter	Newline
Esc	Remove the cursor leaving the characters unchanged.
Space	Insert a space.
Home	Move the cursor to the beginning.
End	Move the cursor to the end.
Alt + Enter	Confirm the entered text and exit the text input mode.

Standard tool operations

By clicking a tool in the tool operation section, you can use the function provided by the tool.

The tool operation continues until you select a different tool.

Other standard operations

The following standard operations can be carried out with the keyboard alone.

Key	Operation
Ctrl + z	Return to the previous state (Undo function)
Ctrl + y	Advance to the next state (Redo function)
Ctrl + x	Cut out an object
Ctrl + c	Copy an object In text input mode: copy the selected text
Ctrl + v	Paste an object In text input mode: paste the copied or cut text with the existing attributes where it is being pasted
Ctrl + a	Select all objects
Delete, Backspace	Delete an object

Object selection operations

- 1 Click the selection tool or move tool.

The icon turns green, and you can now select an object.



- 2 Click an object, or define a range by dragging.



Or

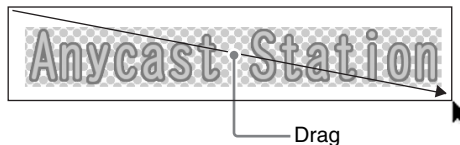

An orange border appears around the object.
This is the selected state.



Notes

- If you drag over a range, this selects all objects within the range.

- When there are multiple objects, you can use the keyboard Tab key to move the selection to the next object.

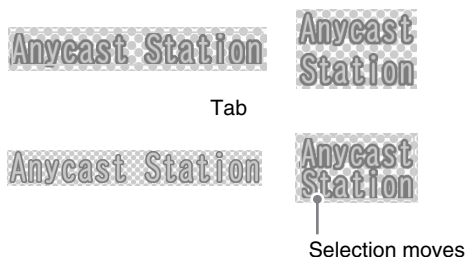

Press the Shift+Tab keys to move the selection in the reverse direction.

- Hold down the Shift key and click an object to add to the selection.
- Click on the selected text object once more to switch to text input mode (page 96).

File Operations

This section describes file operations, including saving and deleting titles created with the typing tool software, export, and so on.

Creating a new file

In the file operation section, click the [New] button.

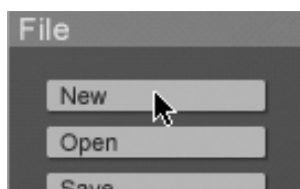

A new sheet appears.

Opening an existing file

- 1 In the file operation section, click the [Open] button.

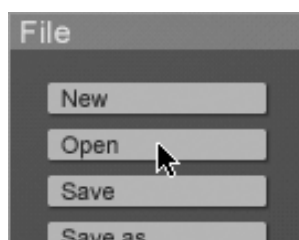

The [Open] screen appears.

- 2 Select the file name from the list.

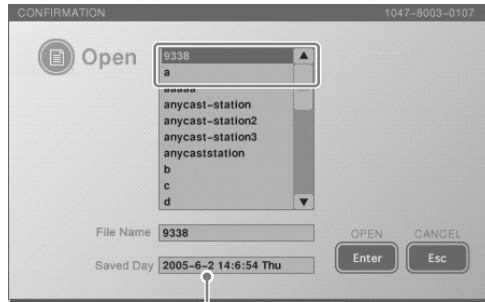

Last saved date of selected file

- 3 Click the [Enter].
This opens the selected file.

Saving a file

- 1 In the file operation section, click the [Save] button.

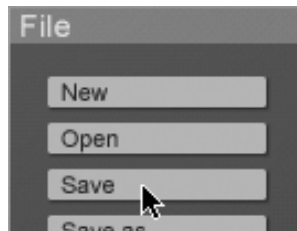

The [Save] screen appears.

- 2 Enter the file name in [File Name].

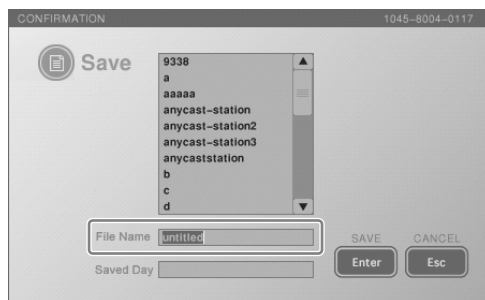

Caution

You can enter a file name as up to 20 alphanumeric characters, but there may not be room for the full name in text boxes or lists, or in the Anycast Station main software INT material selection menu.

3 Click the [Enter].

A message appears while saving, and the file is saved.

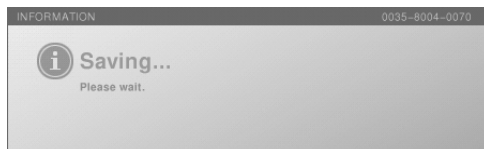

The file is simultaneously saved in the Anycast Station main software. In the Anycast Station main software, the saved file appears if you press the “INT” NEXT selection button.

Caution

If a file of the same name exists in the Anycast Station main software, it will be overwritten.

Notes

- When a file consisting of multiple sheets is saved, the second and subsequent sheets are named as follows with the file name + sheet number in the Anycast Station main software.

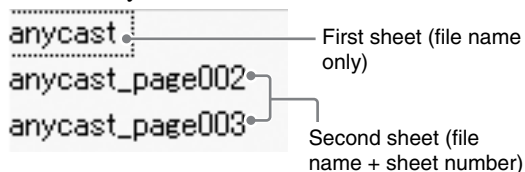

- A saved TIFF/TARGA file is saved with an alpha channel.

Saving a file with a new name

1 In the file operation section, click the [Save as...] button.

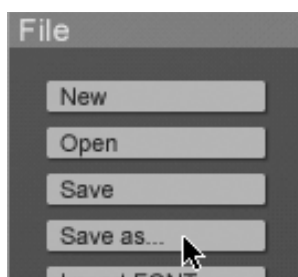

The [Save] screen appears.

2 Enter the file name in [File Name].

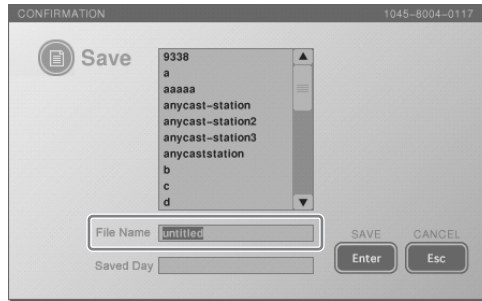

Caution

You can enter a file name as up to 20 alphanumeric characters, but there may not be room for the full name in text boxes or lists, or in the Anycast Station main software INT material selection menu.

- 3 Click the [Enter].

A message appears while saving, and the file is saved.

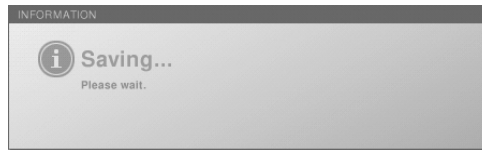

The file is simultaneously saved in the Anycast Station main software. In the Anycast Station main software, the saved file appears if you press the “INT” NEXT selection button.

Caution

If a file of the same name exists in the Anycast Station main software, it will be overwritten.

Deleting a file

- 1 In the file operation section, click the [Delete] button.

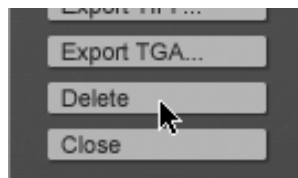

The [Delete] screen appears.

- 2 Select the file name from the list.



- 3 Click the [Enter].
A confirmation message appears.

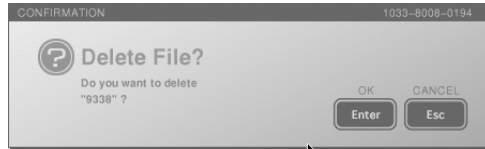

- 4 Click the [Enter].
This deletes the selected file.

Exporting a file

By exporting a file created in the text typing tool software to a “Memory Stick” or USB flash memory, you can use the file in another system. You can export the file in TIFF format or TARGA format at 1280×960 size.

- 1 Insert the “Memory Stick” or USB flash memory in the rear panel “Memory Stick” slot or USB connector.
The upper USB connector is number 1, and the lower connector is number 2.

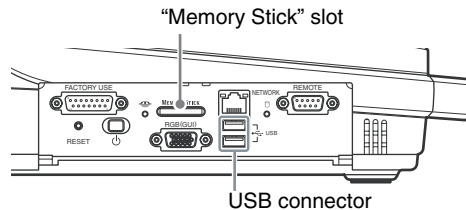

- 2 Open the file to be exported.
For the method of opening a file see “Opening an existing file” (page 88).
- 3 In the file operation section, click the [Export TIFF...] button, or [Export TGA...] button.



The following confirmation message appears.



- 4** Select where to save the file, and click [Enter].
The following confirmation message appears.

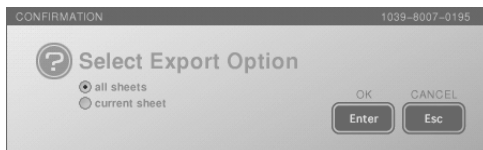

- 5** If the opened file includes multiple sheets, select either [all sheet] or [current sheet].
all sheet: export all sheets within the file.
current sheet: export the currently displayed sheet only.

Note

If there is only one sheet in the file, this message does not appear.

- 6** Click the [Enter].
The [Save] screen appears.
- 7** Enter the file name in [File Name].



- 8** Click the [Enter].
The following message appears, and the file is exported to the “Memory Stick” or USB flash memory.

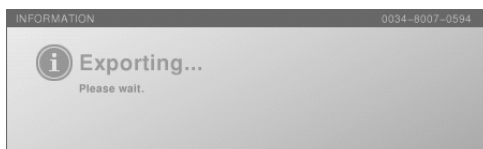

Notes

- When a file consisting of multiple sheets is exported, the second and subsequent sheets are named as follows with the file name + sheet number.

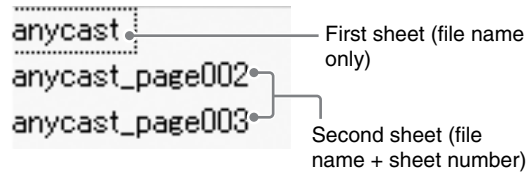

- An exported TIFF/TARGA file is saved with an alpha channel.



Working on Text Objects

This section describes how to create a text object, and then apply modifiers to the text.

Creating a text object

- 1 Click the text tool.

The icon turns green, and the system is now in text input mode (in which text input is possible).



- 2 Click where you want to enter text.

The cursor appears.

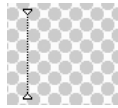

- 3 Enter text from the keyboard.

As you enter text, it appears in a pink and black dotted frame.



Notes

- For details of confirming the text, see “Standard operations for text input” (page 86).
- If input with a font only supporting numerals, spaces are input.

Changing the text font

- 1 Click the selection tool, to select the text object (page 87).

An orange frame appears around the text object.



- 2 Click the ▼ button by the font name in the font operation section.

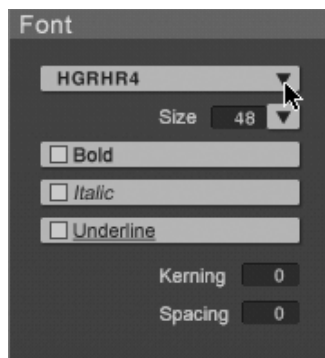

The pull-down list appears.

- 3 Select a font.

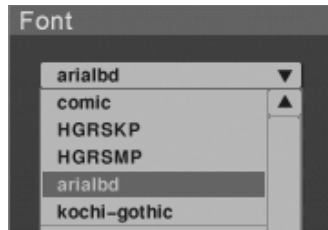

This changes the selected font.



Editing the text

- 1 Click the selection tool, to select the text object (page 87).
An orange border appears around the text object.



- 2 Click the selected text object once more.
The frame changes to a pink and black dotted line, and the cursor appears, switching to text input mode.



- 3 Edit the text.

Changing the font size

- 1 Click the selection tool, to select the text object (page 87).
An orange border appears around the text object.



- 2 Click the [Size] ▼ button in the font operation section.

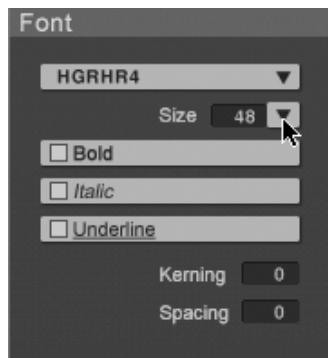

3 Select the size.

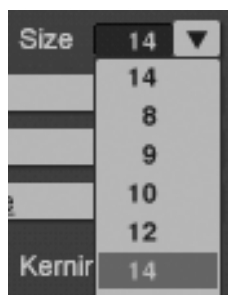

This changes the selected size.



Note

You can also change the size by directly entering a numeric value in the [Size] box. Click the box, enter the numeric value from the keyboard, then press the Enter key.

Changing the font style

1 Click the selection tool, to select the text object (page 87). An orange border appears around the text object.



2 Select a style in the font operation section.



This changes the selected style.



Changing the spacing between characters

- 1 Click the selection tool, to select the text object (page 87).
An orange border appears around the text object.



- 2 Click the [Kerning] input box in the font operation section, and enter the numeric value from the keyboard.

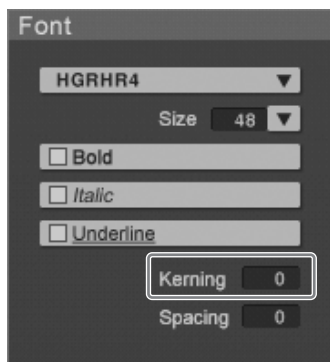

- 3 Press the Enter key.
This changes to the selected spacing.



Note

The numeric value zero is the basepoint for the spacing. By entering a negative value, you can make the spacing narrower.

Changing the spacing between lines

- 1 Click the selection tool, to select the text object (page 87).
An orange border appears around the text object.



- 2 Click the [Spacing] input box in the font operation section, and enter the numeric value from the keyboard.



- 3 Press the Enter key.
This changes to the selected spacing.

**Note**

The numeric value zero is the basepoint for the spacing. By entering a negative value, you can make the spacing narrower.

Aligning text

You can align a text object with multiple lines to the left, to the right, or in the center.

- 1 Click the selection tool, and select the text object with multiple lines (page 87).
An orange border appears around the text object.

Note

The following figure shows left alignment as an example.

ANYCAST STATION
AWS-G500

- 2 Click the center align button in the font operation section.



This center-aligns the text.

ANYCAST STATION
AWS-G500

Changing the text color

- 1 Click the selection tool, to select the text object (page 87).
An orange border appears around the text object.

Anycast Station

- 2 Click one of the color selection buttons in the Color tab.

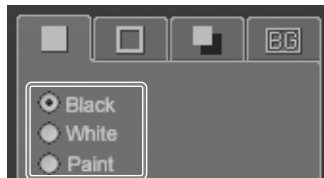

The text appears as follows.

Black

Anycast Station

White

Anycast Station

Paint

Anycast Station

When [Paint] is selected, see the section “Creating a color in the color creation section” (page 108) on adjusting the color.

Making changes to the character outlines

- 1 Click the selection tool, to select the text object (page 87).
An orange border appears around the text object.



- 2 Select the Edge tab.
- 3 Make the following settings for the outline desired.

To change the color of the outline

Change the color as desired in the color creation section.



For details, see the section “Creating a color in the color creation section” (page 108).

To remove the character outlines

In the Edge tab, select [None].

The outlines disappear.



To change the thickness of the outlines

Click the [Width] ▼ button, and select the thickness.



Working on Line Objects

This section describes how to create a line object, and then change the line style or color.

Creating a line object

- 1 Click the line tool.



The icon turns green, and you can now draw a line.

- 2 Draw a line.
Click at the start position, and drag to draw the line.

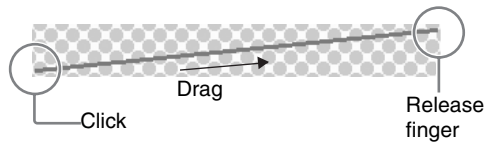

Note

If you drag with the Shift key held down, you can draw horizontal or vertical lines.
 If you perform a click operation, this creates a square on the clicked position with a line thickness equal to the [Width] setting in the Edge tab.

Changing the length or direction of a line

- 1 Click the line tool.
The icon turns green.



- 2 Point at either end of the line using the mouse.
The mouse pointer changes to .

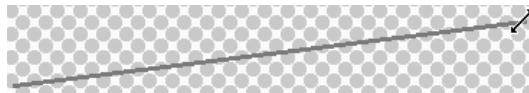

- 3 Click and drag.
An orange border appears around the line object, and you can change the length or direction of the line.

Changing the line style

- 1 Click the selection tool, to select the line object (page 87).
An orange border appears around the line object.
- 2 Click one of the line selection buttons in the Edge tab.

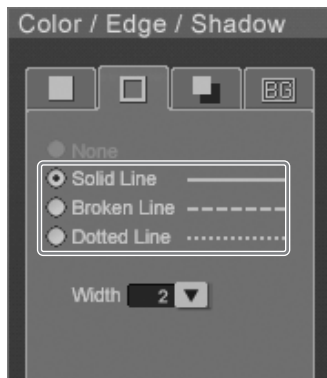

The line appears as follows.

Solid Line

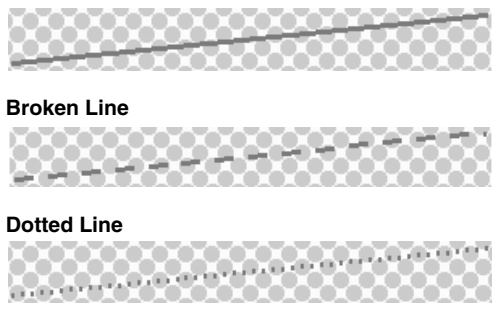

Broken Line

Dotted Line

Changing the line thickness

- 1 Click the selection tool, to select the line object (page 87).
An orange border appears around the line object.
- 2 Click the [Width] ▼ button in the Edge tab.

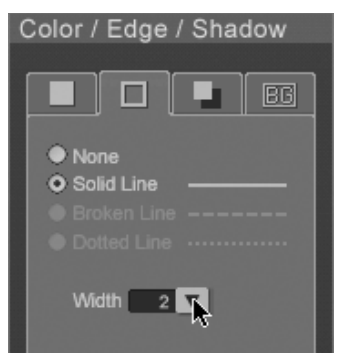

The pull-down list appears.

- 3 Select the thickness.

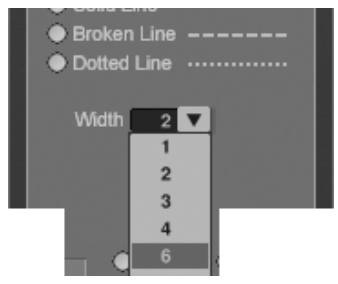

This changes the line to the selected thickness.

Note

You can also change the size by directly entering a numeric value in the [Width] box.
Click the box, enter the numeric value from the keyboard, then press the Enter key.

Changing the line color

- 1 Click the selection tool, to select the line object (page 87).
An orange border appears around the line object.

- 2 Select the color in the color creation section.

For details of color adjustment, see “Creating a color in the color creation section” (page 108).

This changes the color.

Shadow Operations

This section describes how to create shadows, and set the direction and distance, and adjust the degree of blurring.

Note

This section describes the example of a text object.

Applying a shadow

- 1 Click the selection tool, and select the object (page 87).
An orange border appears around the object.



- 2 Select the [Shadow] tab.
- 3 Select the [Shadow-Normal] or [Shadow-Blur] shadow type selection button.

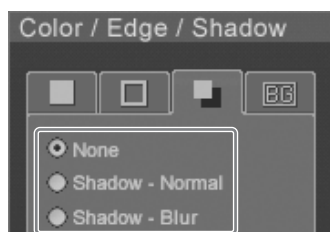

The following display appears.

Shadow - Normal



Shadow - Blur



Changing the shadow angle

- 1 Click the selection tool, and select the object with the shadow (page 87).
An orange border appears around the object.



- 2 Click the compass, and move the needle to the desired shadow direction.



The shadow direction changes as follows.



Note

You can also enter a numeric value in [Degree], to change the direction.

Changing the shadow distance

- 1 Click the selection tool, and select the object with the shadow (page 87). An orange border appears around the object.



- 2 Enter a numeric value in [Distance].



The shadow distance changes as follows.



Changing the degree of blurring of a shadow

- 1 Click the selection tool, and select an object with shadow (Shadow - Blur) applied (page 87). An orange border appears around the object.



- 2 Enter a numeric value in [Softness].



The degree of blurring of the shadow changes as follows.



Background Color Operations (Creating Telop and Flip)

Telop



Flip

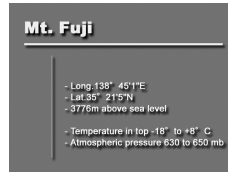

Creating a telop for keying (transparent for keying)

When the created title is used as a key source in the Anycast Station main software, the background is transparent (alpha value 100%), so that the background does not appear.



Note

On the screen when the [Keying] check box is unselected, and in the Anycast Station main software viewer, the background appears as whichever of black and white it is set to, but when used as a key source, the background is transparent.

- 1 Select the [Background] tab.
- 2 Select the [Black] or [White] color selection button.

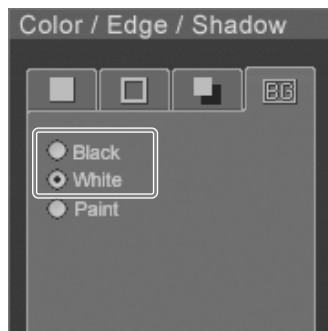

Note

To create a flip with a solid white or black background, select [Paint], and set black or white. For more details, see the section, “Creating a flip (for keying with a background color)” (page 107).

Creating a flip (for keying with a background color)

If you set any color for the background, when used as a key source in the Anycast Station main software, the background color appears unchanged.

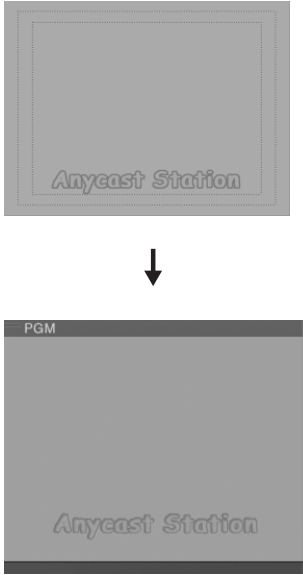

- 1 Select the [Background] tab.
- 2 Select the [Paint] color selection button.

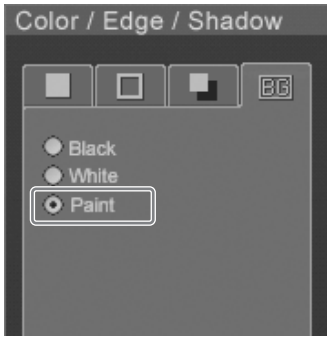

- 3 Create a color in the color creation section.
For details of color creation, see “Creating a color in the color creation section” (page 108).

The background changes to the selected color.

Notes

- If the transparency is set, by selecting the [Keying] check box, you can check the effect of the transparency.

- Even if the transparency is set, while the [Keying] check box is unselected, on the screen and in the Anycast Station main software viewer, the image appears with no transparency, but in actual keying, the background is transparent.
- You can set a different background color for each sheet.

Color Operations

This section describes how to create a color.

Creating a color in the color creation section

In the color creation section of each tab of the modifier operation section, you can create any desired color.

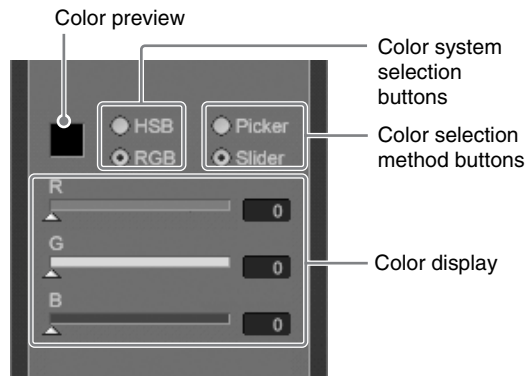

Use the following procedure to create a color.

- 1 Select [HSB] or [RGB] as the color system.
In each of these systems, you specify three parameters to create the color.

[HSB]

H: Hue
S: Saturation
B: Brightness

[RGB]

R: Red
G: Green
B: Blue

- 2 Select [Picker] or [Slider] depending on which color selection method you want to use.

Use the following procedure to specify the color.

When [Picker] is selected

Move the mouse pointer to the desired point in the color field and click, or specify the color by numeric value input.

When [HSB] is selected

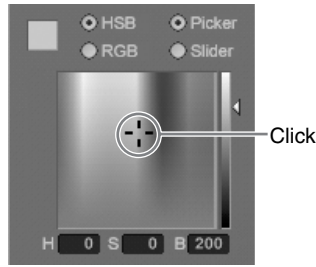

When [RGB] is selected

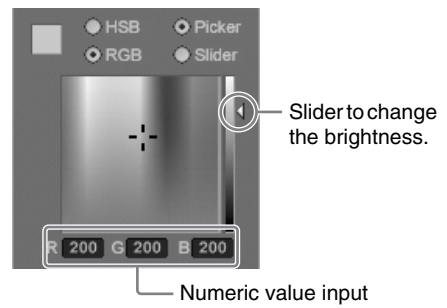

Note

If you move the slider (on the right of the color field) toward the top or bottom, then whatever color you select, only white or black will appear. Setting a value of about 200 makes it easiest to distinguish the colors.

When [Slider] is selected

Move the sliders, or specify the color by numeric value input.

When [HSB] is selected

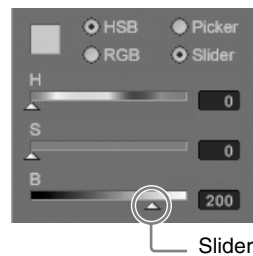

When [RGB] is selected

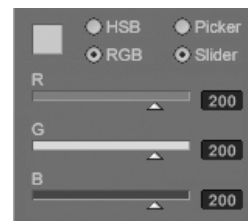

Note

When [HSB] and [Slider] are selected, setting the [B] and [S] numeric value to about 200, and then moving the [H] slider makes it easier to distinguish the colors.

Changing the color using the Eyedropper tool

You can set the color of an object to be the same as a color used in another object.

- 1 Click the selection tool, and select the object whose color you want to change.





2 Select the desired tab.

To change the text color: [Color] tab

To change the character outline or line object color: [Edge] tab

Example:

Here the [Edge] tab is selected, to change the character outline color.

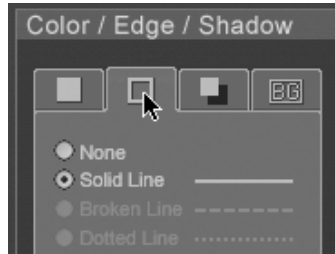

3 Click the eyedropper tool.



The mouse pointer changes to an eyedropper.

4 With the eyedropper, click on the color you want to use.



Note

You can pick the color with the eyedropper from any part of the screen: background, text, character outline, line object, checkerboard pattern, or captured image.

This changes to the selected color.



Changing the transparency

You can set a transparency value for the color of an object.

Note

This section describes the example of a text object.

- 1 Click the selection tool, and select the object (page 87).
An orange border appears around the object.



- 2 Select the [Color] tab.

Note

To give a transparent color to a line object select the [Edge] tab; to give a transparent color to a shadow select the [Shadow] tab; and to give a transparent color to the background select the [Back Ground] tab.

- 3 Move the [Transparency] slider, or enter a numeric value for the transparency.



The color of the text becomes transparent as follows.



Caution

If the characters have outlines, these also become transparent. It is not possible to make the outline independently transparent.

Applying a color gradation

You can apply a gradation to the color of an object.

Note

This section describes the example of a text object.

- 1 Click the selection tool, and select the object (page 87).
An orange border appears around the object.



- 2 Select the [Color] tab.

Note

To apply a gradation to a line object, select the [Edge] tab.

- 3 Select the [Gradation-Pattern] check box.



This applies the color gradation as follows.



Changing the gradation pattern

- 1 Click the selection tool, and select the object with the gradation (page 87).

An orange border appears around the object.



- 2 Select the [Color] tab.
- 3 Click the [Gradation-Pattern] ▼ button.

The following patterns appear.



- 4 Select a pattern.



This changes the pattern.

Note

Of the four patterns, the two patterns at the ends use the selection color for the white part of the pattern, and provide a gradation from the selection color to black. The two inner patterns use the selection color for the white part of the pattern, and provide a gradation from the selection color to white.

Gradation to black



Gradation to white



Object Layout

This section describes how to change the object front-to-back positioning, and adjust the layout.

Changing the object front-to-back positioning

The tools used to carry out front-to-back positioning and their functions are as follows.

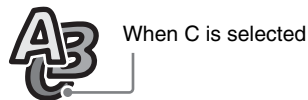

Bring to front



C brings to the front.



Bring forward



C brings forward by one level.

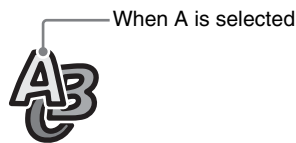

Move backward



A moves back by one level.



Move to back



A moves to the back.

Example:
To move the object from the back to the front

- 1 Click the selection tool, and select the object to be moved.

Select the object at the back



An orange frame appears around the object, and it appears at the front.

- 2 Click the Move to front tool.

This moves the selected object to the front.



Positioning objects

You can center the selected object vertically or horizontally within the frame. The tools used to carry out centering and their functions are as follows.



Vertical centering

This centers vertically within the frame.

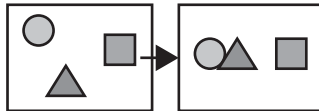

Horizontal centering

This centers horizontally within the frame.

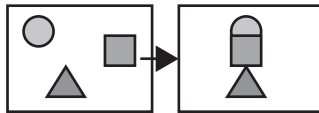

Lower/third positioning

This positions the object at the bottom of the screen.

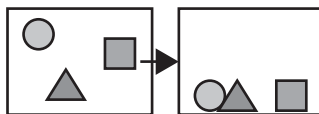

Note

Object position moves to the safety zone bottom position inside the sheet.

The operation is the same with all tools.

**Example:
Centering an object vertically**

- 1 Click the selection tool, to select the object you want to position.



- 2 Click the vertical centering tool.
This centers the selected object vertically.



Adding and Deleting Sheets

In the text typing tool software you can handle multiple sheets in a single file.

Adding a new sheet

- 1 Click the [New Sheet] button in the sheet operation section.

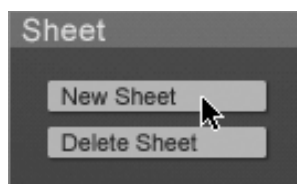

The following confirmation message appears.

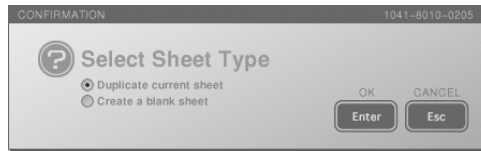

- 2 Select [Duplicate current sheet] or [Create a blank sheet].

Duplicate current sheet: Create a new sheet as a copy of the currently open sheet object .

Create a blank sheet: Create a new, blank sheet.

- 3 Click the [Enter].

The new sheet is inserted as the next page after the open sheet.

Deleting a sheet

- 1 With the page operation section (page 34), display the sheet you want to delete.
- 2 Click the [Delete Sheet] button in the sheet operation section.



This deletes the displayed sheets.

Simulating the Keing Effects

By displaying an image captured from the program output video, or the checkered pattern as the background, you can check the keying effect of a created object.

Displaying a captured program output video image as the background

- 1 Open the file you want to simulate a keying effect.

For the method of opening the file, see “Opening an existing file” (page 88).

By default, the internal checkered pattern appears in the background, so that the keying image can be seen.

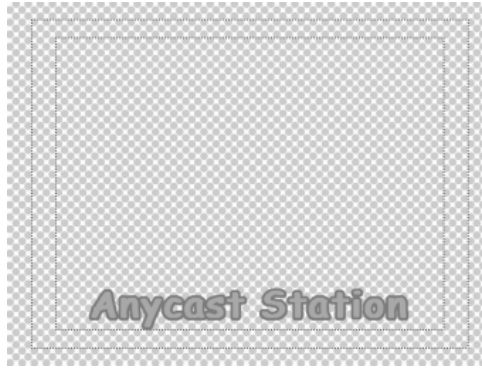

- 2** Unselect the [Checker] checkbox in the view operation section.
 When you unselect this, the image captured from program output video when you switched from the Anycast Station main software appears in the background.



Caution

Always ensure that the [Keying] checkbox in the view operation section is selected.

- 3** Click the [Capture] button in the view operation section.
 Each time you click, this captures the current image.

Combining the [Checker] and [Keying] checkboxes in the view operation section

The effects of selecting combinations of the [Checker] and [Keying] checkboxes are as follows.

[Checker] and [Keying] checkbox combination	Display effect
<input checked="" type="checkbox"/> Checker + <input checked="" type="checkbox"/> Keying	Checkered pattern + object When the color selection button in the [Back Ground] tab is [Paint]: checkered pattern + background of user-created background color (transparency setting: can be checked) + object
<input type="checkbox"/> Checker + <input checked="" type="checkbox"/> Keying	Program output capture image + object If the [Back Ground] tab color selection button is [Paint]: Program output capture image + background of user-created background color (transparency setting: can be checked) + object

[Checker] and [Keying] checkbox combination	Display effect
<input type="checkbox"/> Checker + <input type="checkbox"/> Keying	Background white or black, or user-created background color (transparency setting: cannot be checked) + object

Note

For details of the [Back Ground] tab settings and the [Keying] button On/Off setting, see the section, “Background Color Operations (Creating Telop and Flip)” (page 106).

Displaying the safe zone

The “safe zone” refers to the area of the frame within which an object can be inserted as a key in the program output video without risk of being outside the viewing limits on a connected output device.

When the [Safe Zone] checkbox in the view operation section is selected, the safe zone appears.

Unselect the checkbox to hide the safe zone.

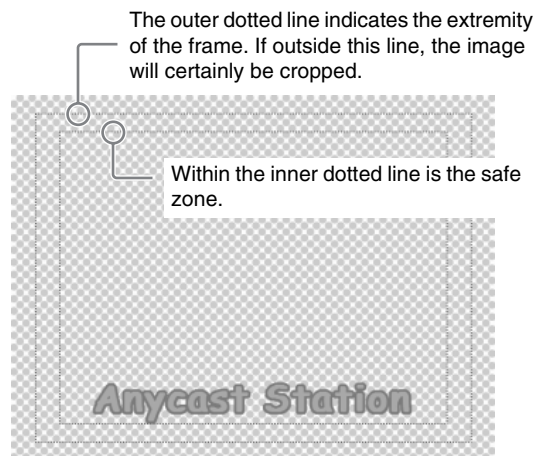

Key Combination in the Anycast Station Main Software

Start the Anycast Station main software, and use the file created in the text typing tool software for a keying.

- 1 Click the [Exit] button at the lower left of the screen.
This starts the Anycast Station main software.

Note

You can also use the keyboard F5 (Fn+5) key to switch to the Anycast Station main software.

For details, see “To close the text typing tool software and start the Anycast Station main software” (page 85).

- 2 Press the “INT” NEXT selection button.
The INT material selection menu appears.

- 3 Select the file or sheet, and confirm.

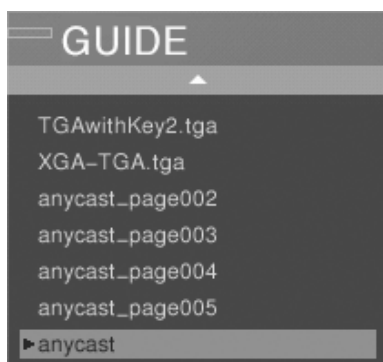

Notes

- If the file consists of multiple sheets, the first sheet is identified as the file name, and the second and subsequent sheets are identified as the file name + sheet number.
- Files created in the text typing tool software have no extension.

The selected sheet appears as the “INT” source viewer and PVW viewer.

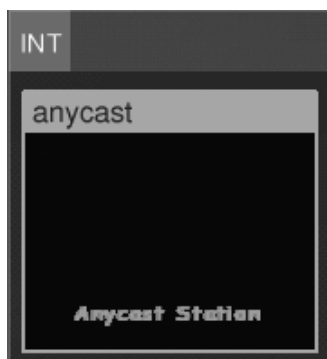

You can combine as a downstream key (DSK) or luminance key.

For details, see the section “Using the Downstream Key (DSK) Function to Add Text or an Image” (page 69) and “Using Luminance Keying” (page 74).

Importing a Font File

You can import a font file that has been saved on a “Memory Stick” or USB flash memory.

The font file must have been saved in the dedicated folder for fonts: MSSONY/PRO/LPS/ANYCAST/FONT.

- 1 Insert the “Memory Stick” or USB flash memory in the rear panel “Memory Stick” slot or USB connector.
The upper USB connector is number 1, and the lower connector is number 2.

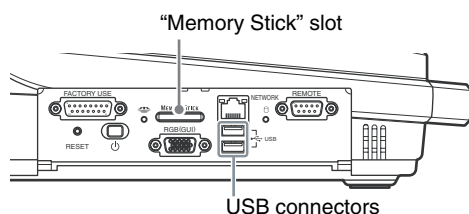

- 2 In the file operation section, click the [Import FONT...] button.

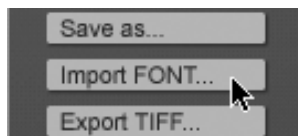

The following confirmation message appears.

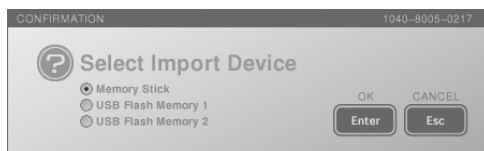

- 3 Select the inserted media, and click [Enter].
While importing, the following message appears.

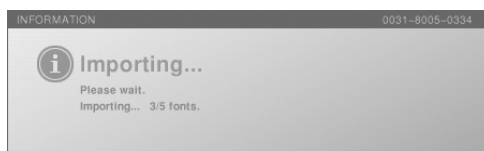

When the import is completed, a completion message appears, and the font is added to the [Font Name] list.

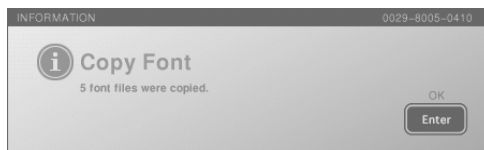

- 4 Click the [Enter].

Caution

- This imports all font files within the FONT directory of the “Memory Stick” or USB flash memory. If the same font file exists in this unit, it is overwritten.
- The only font files that can be imported are TrueType fonts, with a file extension “.ttf”.
- Even if an imported font is one the user has purchased, for commercial use, such as providing telop on a broadcast, the permission of the provider of the font for commercial use of the font may be necessary.
Note that the three fonts provided with the Text Typing Tool may be used for commercial purposes without further formality.

Controlling Cameras

This unit is equipped with a VISCA controller. VISCA (Video System Control Architecture) is a technology used for connecting a video device to a controller, and controlling the video device from the controller. In this unit, you can remotely control a camera supporting VISCA protocol connected to the VISCA connector.

The remote control operations available include the following.

- Pan
- Tilt
- Zoom
- Focus
- Aperture (iris) control
- White balance adjustment

Note

The controllable range depends on the camera you are using.

Registering Cameras to be Controlled

By registering a camera supporting the VISCA protocol with this unit you can control it from the unit.

You can connect up to seven cameras supporting VISCA protocol to this unit in a daisy-chain, and control the cameras from this unit at addresses VISCA 1 to VISCA 7 in sequence. In this unit, you control a camera by specifying one of these addresses.

Caution

The maximum number of simultaneous video signal inputs to this unit is six (when all of the rear panel interface modules are all SD video interface modules).

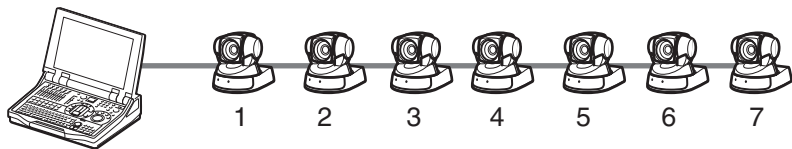

- 1** Connect the camera(s) supporting VISCA protocol to this unit.
For camera connection, refer to page 46.
- 2** Assign the input signal from the camera to a selection button.
Refer to “Assigning video input signals to the selection buttons” (page 53).
- 3** ① Select the number of a selection button assigned to a camera supporting the VISCA protocol, and confirm; ② select [Control], and confirm; ③ select the camera address, and confirm.

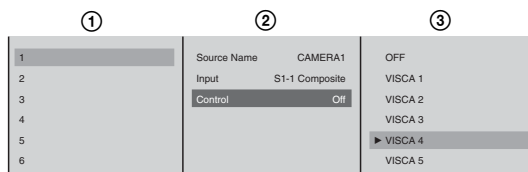

4 Press the MENU button to close the menu.

Controlling Camera Manually

Control a camera manually supporting the VISCA protocol from this unit. With the default settings of this unit, focus and iris settings are set to auto, and white balance setting is set to “no operation”. To control these manually, you need to set them in the menu.

Carrying out manual control

1 Press the NEXT selection button to which the camera video is assigned.

Note

To control the camera, follow the procedure in “Registering Cameras to be Controlled” (page 121).

A guide to operations appears in the camera control guide.

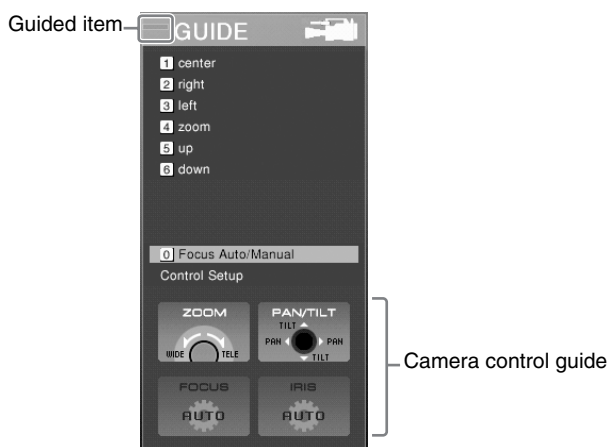

If the focusing and iris control are set to auto, then “[AUTO]” appears. To change the settings manually, refer to “Setting the Camera Control” (page 126).

- Following the guide, control the camera, using the front panel buttons and dials.

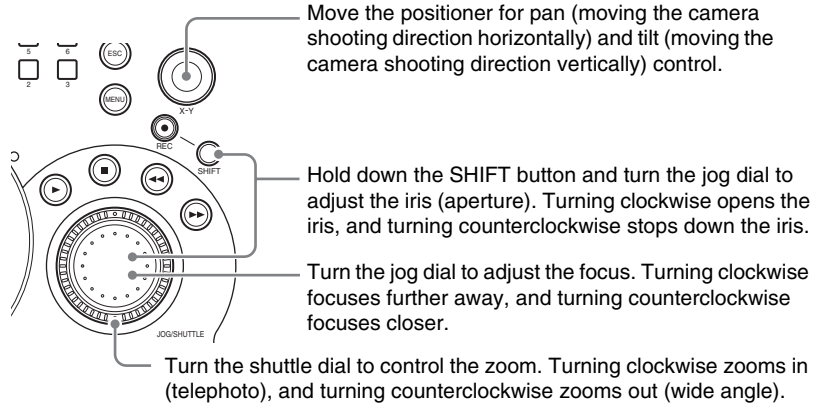

Storing a Camera Preset

The camera preset function allows you to save the state of the camera supporting VISCA protocol to one of the numeric buttons on the front panel. Then by pressing the numeric button, you can automatically set the camera to the saved state.

For example, during a lecture relay, you can store settings for standard shots, such as a speaker close-up, speaker full-body shot, guest panel, or audience view, simplifying the work of switching among these views.

In the camera preset, you can save the pan, tilt, zoom, and focus settings, the aperture (iris) status, the white balance adjustment, the control mode (auto/manual, etc.).

Caution

If the camera you are using is an EVI-D100/EVI-D100P, set the camera BACK UP switch to the ON position before storing.

Storing a camera preset

- Press the NEXT selection button to which the camera video is assigned. A camera preset menu appears in the menu display.

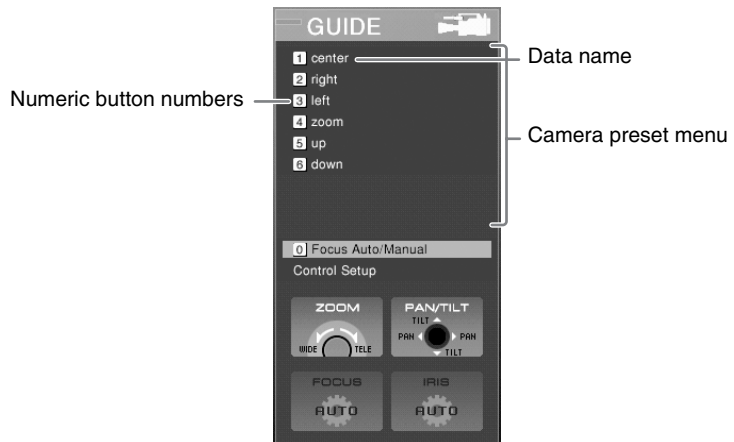

- 2 Control the camera to determine the shot.
- 3 With the jog roller, select the camera preset menu number (from 1 to 6), and confirm.

The camera preset settings menu appears.

- 4 Set the following items as required.

Applying a name to the preset

- ① Select [Data Name], and confirm; ② enter the name in the input box, and confirm.

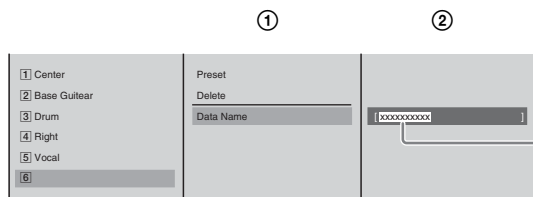

Enter up to 20 alphanumeric characters.
* The camera preset menu can only display a limited number of characters.

- 5 Select [Preset], and confirm.

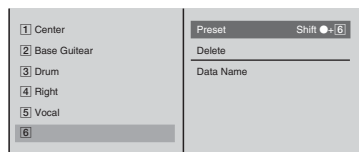

This saves the preset in the numeric button.
The saved preset appears in the camera preset menu.

Note

Even if the camera preset menu is not displayed, you can register a camera preset by holding down the Shift button and pressing any numeric button (between 1 and 6).

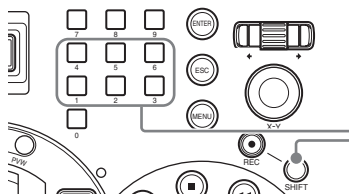

Hold down the Shift button, and press one of numeric buttons 1 to 6.

Recalling a preset

- 1 Press the NEXT selection button to which the camera video is assigned.
- 2 Using the numeric buttons on the front panel, press the number in which the preset is saved.

The numeric button lights amber, and the camera is set to the preset state.

The selected number appears in amber.



Deleting a saved preset

- 1 Press the NEXT selection button to which the camera video is assigned. A camera preset menu appears in the menu display.
- 2 Select the number of the preset you want to delete with the jog roller, and confirm. The camera preset settings menu appears.
- 3 Select [Delete], and confirm.

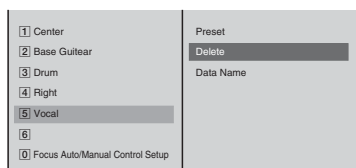

A confirmation message appears, as follows.

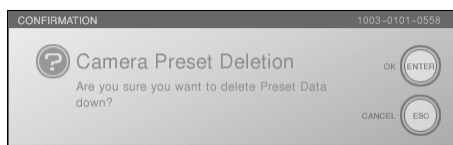

- 4 Press the ENTER button. This deletes the preset, and the number changes to gray.

Setting the Camera Control

To change the default settings of this unit, or to enable pan, tilt and zoom for a ceiling-mounted camera, use the following procedure.

- 1 Press the NEXT selection button to which the camera video is assigned. A guide menu appears in the menu display.
- 2 With the jog roller, select [Control Setup], and confirm. The submenu appears.

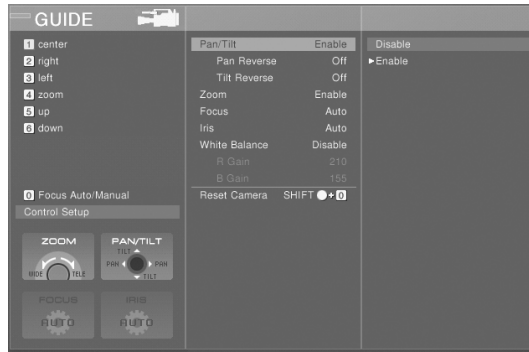

- 3 Set the following items in the submenu.

Disabling remote control of pan and tilt, or zoom

- ① Select [Pan/Tilt] or [Zoom], and confirm; ② in the submenu select [Disable], and confirm.

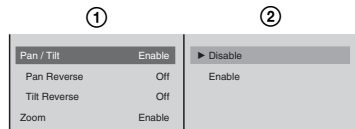

Reversing directions for ceiling-mounted cameras

When a camera is ceiling-mounted, you can reverse the pan and tilt directions.

- ① Select [Pan Reverse] or [Tilt Reverse], and confirm; ② select [On], and confirm.

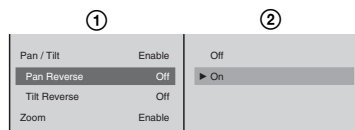

Enabling manual focus and iris control

- ① Select [Focus] or [Iris], and confirm; ② select [Manual], and confirm.

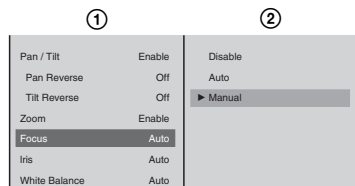

Note

You can switch the auto focus and manual focus by pressing “0” of the numeric keys.

Manually controlling white balance

① Select [White Balance], and confirm; ② set [Manual], and confirm.

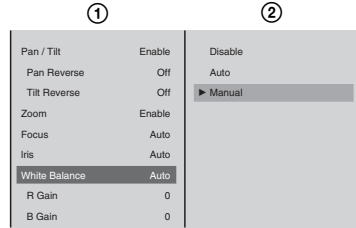

③ Select [R Gain] or [B Gain], and confirm; ④ move the slider to adjust the values.

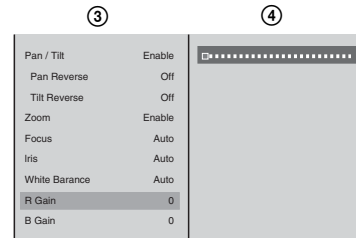

Note

When not using control from this unit, select [Disable].

4 Press the MENU button to close the guide menu.

Resetting the Camera

After starting up this unit, carry out this procedure after powering the camera supporting the VISCA protocol off and on again, or disconnecting and reconnecting the VISCA cable.

Perform this operation even if “No Response” appears as the camera status.

- 1** Press the NEXT selection button to which the camera video is assigned. A camera preset menu appears in the menu display.
- 2** With the jog roller, select [Control Setup], and confirm.
- 3** In the submenu, select [Reset Camera], and confirm.

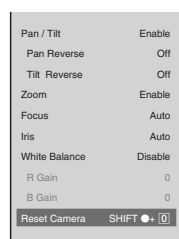

Note

You can also reset the camera by holding down the Shift button and pressing the numeric 0 button.

About Camera Tallies

If using a camera (such as the BRC-300) that supports the camera tally function, when the input from this camera is being used as the program output, the camera tally lights.

Caution

Multiple settings are possible for the [Video Input Assign] [Control] setting. In this case, the camera tally lights when the video from any of the source viewers for which the [Control] setting is made is being used for program output.

Notes

- When the video from a camera with the tally lit is being used for program output, then if you press the FTB button, the tally goes off.
- If you open a file on the hard disk in the source viewer assigned to the video from a camera with the tally lit, the tally goes off.

Audio Mixing

This section describes how to perform mixing on the audio signals input to the unit, and output the final audio (output program) from the PGM output connectors.

First assign the audio signals to channel faders, as described in “Audio Signal Related Settings” (page 54).

- 1 Press the CH ON button on the front panel to select the channels that you want to mix.

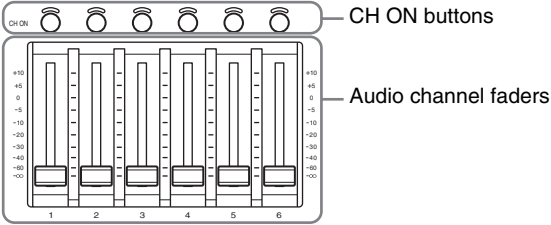

- 2 Adjust the levels with the audio channel faders, and carry out mixing.

Note

For audio input/output signal fine adjustment settings, refer to “Video/Audio Signal Adjustments and Settings” (page 146).

Adjusting the PGM output audio level

Use the PGM fader on the front panel to adjust the level of audio from the PGM output connectors.

Adjusting the monitored audio levels

Adjust the levels of the built-in speakers, headphones, and devices connected to the monitor output connectors with the monitor level adjustment knob on the front panel.

Note

For the selection of audio to be monitored, refer to “Monitoring Output Audio” (page 144).

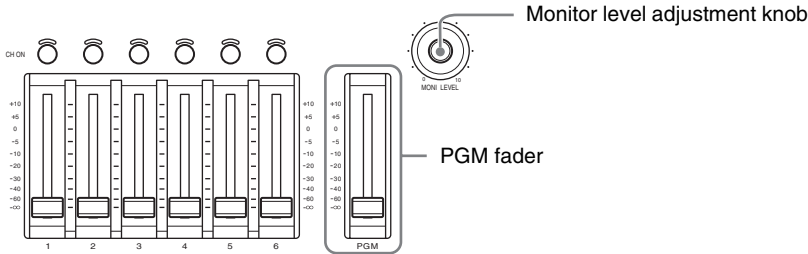

Recording Video and Audio on an External Device

By connecting an external device to the DV connector or the i.LINK connector of the SD interface module (BKAW-570), with the DV connector you can record the program output from this unit, and with the i.LINK connector you can record the input sources to this unit.

Note

The DV connector and the i.LINK connector support different devices and recording formats.

DV connector (DV IN/OUT DV PGM): connect a VCR, to record the program output video and audio.

i.LINK connector (HDD): connect an external hard disk, to record the video and audio input selected with the NEXT selection buttons (page 131).

Caution

If a signal subjected to special processing is input to the synchronization signal, normal recording may not be possible.

Recording Program Output on a VCR

By connecting a VCR to the DV connector (DV IN/OUT) of the SD interface module (BKAW-570) on the rear panel, you can record the program output video in DV format.

Procedure for recording on a VCR

To begin recording to a VCR, select the DV connector to be used for recording.

- 1 Connect the VCR to the DV connector.

Note

Depending on the model of VCR, signal input/output settings may be required. Refer to the Operating Instructions for the device to be connected.

- 2 Press the MENU button.
- 3 In the top menu, select [DV Output].
- 4 ① Select [PGM Output] and confirm; ② Select the DV connector to which the VCR is connected from the list and confirm.

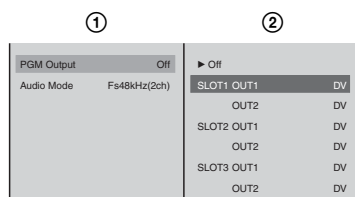

This sets the selected DV connector for program output, and program video is output.

Note

At this point, in the [Video Input Assign] menu and [Audio Input Assign] menu, the same input of the same slot is grayed out, and cannot be selected.

- 5 Press the MENU button, to close the menu.
- 6 Operate the VCR to start recording.

Notes

- The signal is output in DV format, but it is not possible to carry out recording operations on the VCR from this unit.
- When connecting to DV devices, if the video or audio output is lost, or there is noise, disconnecting and reconnecting the cable, or powering the DV device or this unit off and on again may solve the problem.

Recording Inputs on an External Hard Disk

You record the input source on an external hard disk connected to the i.Link connector (HDD) of the interface module.

With video input to an interface module to which an external hard disk drive is connected, and audio with the same source number as the video combined together, two inputs can be recorded simultaneously.

For details of formatting an external hard disk, see the section “Formatting an External Hard Disk” (page 160).

Caution

- It is not possible to record with an external recorder connected to the i.LINK connector (HDD).
- When recording on the hard disk, be sure to read the section “External Hard disk” (page 10).

Recorded settings and file details

Recorded settings

Video	ACCESS menu settings (Adjustment is not possible for DV video)
Audio	ACCESS menu [Input Trim] setting (analog audio only)
	Top menu [Audio MIC/LINE Level] setting

File details

File name	YYMMDD-(source number)-(3-digit suffix).dv
File format	DV format (.dv)
Timecode	Not included

Connecting an external hard disk

- 1 Connect the external hard disk to the i.LINK (HDD) connector of the interface module (6-pin).

Connect the disk to the same interface module as the input you want to record.

i.LINK connector (6-pin)

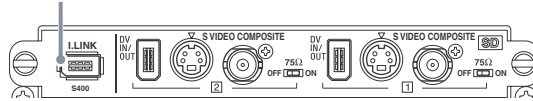

- 2 Power on the hard disk.

Caution

Always connect the hard disk and power it on before starting up this unit.

- 3 Press the  (power) button on the side panel, to start up this unit.

The operation screen appears, and the device status for the source viewer for the interface module to which the hard disk is connected shows the hard disk number, remaining capacity, and available recording time.

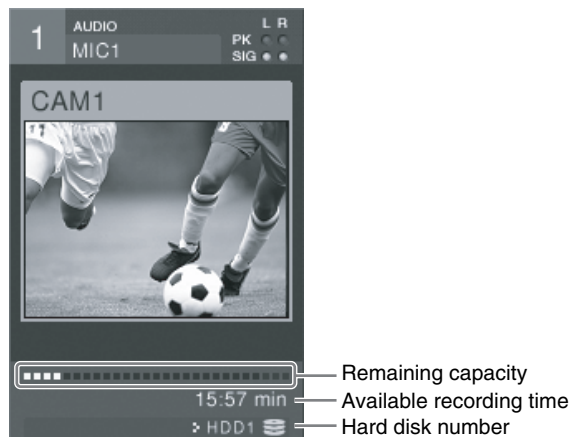

Note

When recording two sources simultaneously, the indicated remaining capacity diminishes at twice the normal rate, and therefore the actual remaining recording time is approximately half of that shown.

Starting recording for each input

- 1 Select the source to be recorded in the NEXT selection buttons.

Caution

The inputs that can be recorded are only those to the external interface module to which the hard disk is connected (inputs for which the source viewer shows the hard disk number and recording status).

- 2** Hold down the REC button and press the PLAY button.

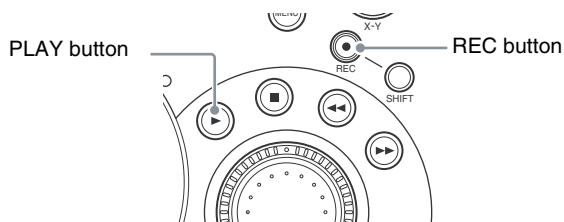

The source viewer device status shows [REC Pause].

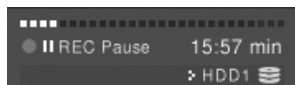

The following confirmation message also appears at the same time.

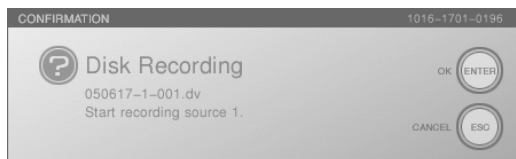

- 3** Press the ENTER button or PLAY button.

The device status indication changes to [REC], and recording starts.



Note

You can repeat steps 1 to 3 for a different source, for simultaneous recording of multiple inputs.



Material recorded

Audio:

- The audio is recorded together with the video assigned to the same source number. It is not possible to record audio only.
- It is not possible to record DV video and analog audio together. If you start recording of DV video and analog audio, a confirmation message appears and DV audio is recorded combined with DV video.

Timecode:

- Not supported.

Stopping recording

- 1 Select the source to be stopped recording in the NEXT selection buttons.
- 2 Hold down the REC button and press the STOP button.
In the device status of the source viewer, the [REC] indication disappears, and recording stops.

Operations on Files on the External Hard Disk

You can carry out operations on files stored on an external hard disk connected to the interface module.

For the method of connection, see the section, “Connecting an external hard disk” (page 132)

File indications

The file name and timecode for a saved file are shown as follows.

File name: YYMMDD-(source number)-(3-digit suffix)

The 3-digit suffix is automatically added, in sequence from 001.

Timecode: always starts from 00:00:00:00.

Playing files

- 1 Press the NEXT selection button for the source viewer showing the hard disk number.

Note

It is not possible to open a file in a source viewer being used for recording.

- 2 Press the same NEXT selection button once more.
A list of files appears in the menu display.

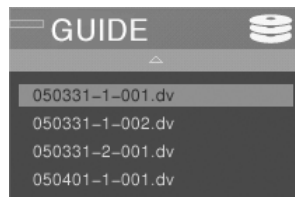
**Caution**

- Only files recorded on this unit appear.
- It is not possible to open a file while it is being recorded.
- **File information**

While you hold down the jog roller → button or keyboard → key, the information for the selected file appears as follows.

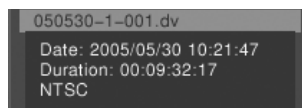

3 Select a file and confirm.

The frame of the file appears in the source viewer and PVW viewer, stationary.

Caution

There may be a delay until the file opens.



4 Press the PLAY button.

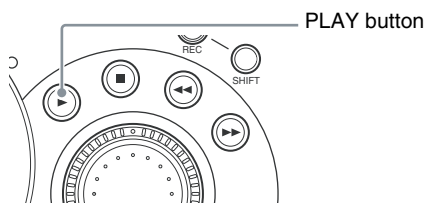

Playback starts in the source viewer and PVW viewer.



Notes on audio playback

When recording analog audio of which the levels were adjusted using [Input Trim] in the ACCESS menu (page 149), note the following points.

If playing back a file on the same source viewer as was used for the recording, we recommend that you set the viewer [Input Trim] setting to 0 dB, before beginning playback. If the setting is left unchanged for playback, then if recorded with a negative value, the value will be even more negative, and if recorded with a positive value, the value will be even more positive.

Rapid recall of the last file played

You can recall the last file played without needing to select it from the file list. In this case, press the NEXT selection button for the source viewer on which you played the file, then press the PLAY button to continue playback (without displaying a file list).

Other playback operations

- 1 Press the NEXT selection button with the same number as the source viewer for the file on which you want to operate.
- 2 Press any of the following buttons to carry out the operation.

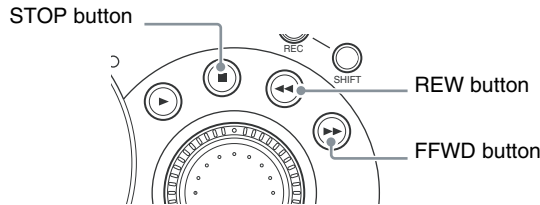

STOP button

Press this during file playback to stop playback of the file.

Press this while stopped to close the file, and return to the video and audio of the assigned input.

REW button

Press this during file playback to play in reverse.

Note

Each time you press, the reverse speed increases (x2, x4, x8, x16, x32, x64). The reverse speed appears in the device status of the source viewer and PVW viewer.

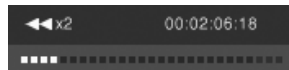

FFWD button

Press this during file playback to play fast forward.

Note

Each time you press, the fast forward speed increases (x2, x4, x8, x16, x32, x64).

The fast forward speed appears in the device status of the source viewer and PVW viewer.



Deleting files

- 1 Press the MENU button.
- 2 In the top menu, select [File Manager].

- 3** ① Select [Delete] and confirm; ② Select the hard disk number and confirm
 ③ Select the file to delete and confirm.

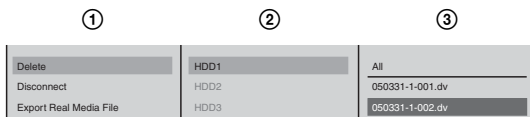

Notes

- If in step ③ you select [All], this deletes all of the files.
- While a file is being recorded, it is not possible to delete files on the same hard disk.

The following confirmation message appears.



- 4** Press the ENTER button, to delete the file.
- 5** Press the MENU button, to close the menu.

Disconnecting the External Hard Disk

When disconnecting the external hard disk, use the following procedure to disconnect safely.

- 1** Press the MENU button.
- 2** In the top menu, select [File Manager].
- 3** ① Select [Disconnect] and confirm; ② Select the hard disk to disconnect, and confirm.

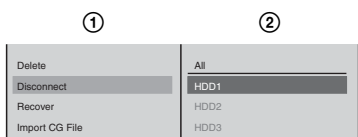

Note

To disconnect all of the hard disks together, select [All]. However, the hard disk can not be disconnected during recording.

The following message appears.

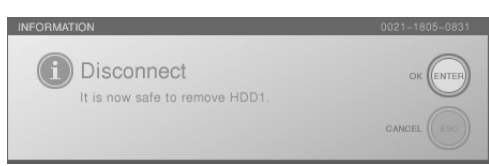

- 4 Press the ENTER button, to close the message.
- 5 Power off the hard disk, and disconnect.

Recovering an External Hard Disk

If as the result of one of the following operations the external hard disk has become inaccessible from another computer or from this unit, then carry out disk recovery.

- If the hard disk is disconnected without carrying out the proper procedure for disconnection on this unit
- If the hard disk is disconnected from a computer without the proper procedure for disconnection

- 1 Press the MENU button.
- 2 In the top menu, select [File Manager].
- 3 ① Select [Recover] and confirm; ② Select [HDD1] and confirm.

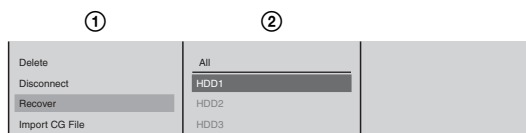

The following confirmation message appears.

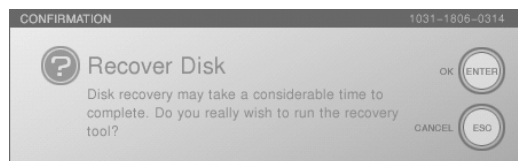

- 4 Press the ENTER button.
Recovery starts.
When recovery is completed, the following message appears.

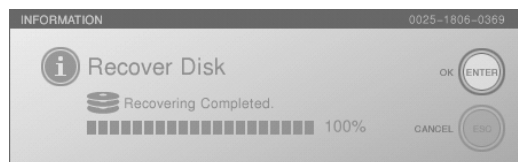

- 5 Press the ENTER button to close the message.
- 6 Press the MENU button, to close the menu.

Caution

If the hard disk was disconnected without carrying out the proper procedure, follow the messages that appear to carry out recovery. It may be possible to access files on the hard disk without carrying out the recovery procedure, but the content of such files is not guaranteed.

Using a Computer to Play Files Recorded on an External Hard Disk

You can play files recorded with this unit, using a computer.

Caution

The proper procedure must be carried out before disconnecting the external hard disk. For details see the section “Disconnecting the External Hard Disk” (page 137).

- 1 Install an ext3 driver in the computer.
- 2 With an IEEE1394 cable, connect the hard disk to the computer.
The disk is mounted as two drives, with volume labels “system” and “data.”
- 3 Select files from the folder anycast/data in the drive with volume label “data,” and play them back.

Disk partitioning

When the external hard disk is formatted on this unit, two partitions are created: a meta partition and a data partition.

Meta partition: administrative information; volume label: “system”

Data partition: storage for created files; volume label: “data”

Caution

On the computer, if you alter the administrative information, or change file names, this will render the files unplayable on this unit.

Note

If the computer system does not support playback of files in DV format (.dv), first convert to a format that can be played.

Using the Intercom Function

Connecting an external intercom system requires a connection operation by the customer.

An intercom system allows the operator to confer with camera operators and others in remote locations. You can use the built-in speakers of this unit and the front panel microphone.

Connecting the Intercom System

Connect the intercom system to the INTERCOM connector on the rear panel. The following shows a connection example of an intercom system.

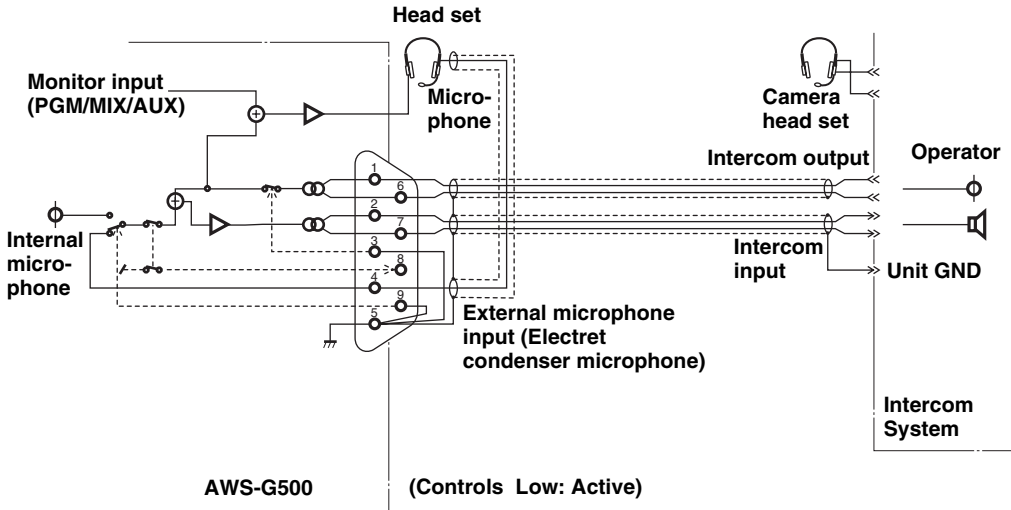

When using a headset, connect the microphone connector to the INTERCOM connector, and connect the headphone connector to the HEADPHONES connector.

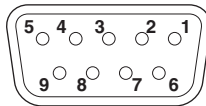

Pin No.	I/O	Signal name	Description
1	I	AUDIO IN (H)	INTERCOM AUDIO SIGNAL INPUT (H)
2	O	AUDIO OUT (H)	INTERCOM AUDIO SIGNAL OUTPUT(H)
3	I	CONTROL IN	INTERCOM RECEIVE CONTROL (LOW ACTIVE)
4	I	MIC IN (+)	ELECTRET CONDENSER MICROPHONE INPUT
5	-	GND	GROUND
6	I	AUDIO IN (C)	INTERCOM AUDIO SIGNAL INPUT (L)
7	O	AUDIO OUT (C)	INTERCOM AUDIO SIGNAL OUTPUT (L)
8	O	CONTROL OUT	TB CONTROL (LOW ACTIVE)
9	I	CONTROL IN	EXT MIC ACTIVE CMD (LOW ACTIVE)

Speaking on the Intercom System

- 1 Connect the external intercom system.
- 2 Press the TB (Talk Back) button, and speak into the front panel microphone (or headset microphone).

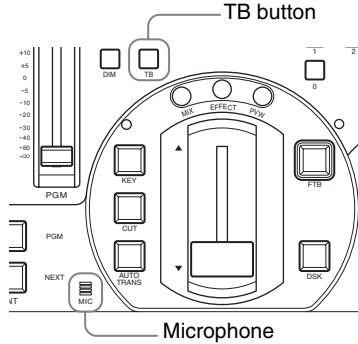

This transmits on the external intercom system. You can listen on the external intercom system using the built-in speakers of this unit or headphones.

- 3 Press the TB button to finish conversation.

Note

While the TB button is lit, the DIM button lights. The relationship between the state of the TB button and the built-in speakers, headphones, and monitor output is as follows.

Monitoring state when using the intercom

Monitor output connector connection	TB button state	Internal speakers		Headphone output		Monitor output
		Output to be monitored *1	Sound from the intercom system	Output to be monitored *1	Sound from the intercom system	
Yes	On (lit)	Mute	Attenuated output *2	Attenuated output *2	Output	Output to be monitored *1 only is output continuously.
	Off	Mute	Output	Output	Output	
No	On (lit)	Attenuated output *2	Attenuated output *2	Attenuated output *2	Output	
	Off	Output	Output	Output	Output	

*1 This indicates whichever of PGM, AUX1, AUX2, and MIX is selected for [Audio Monitor] in the [Audio Utility] top menu.

*2 The audio attenuation ("DIM") function reduces the output level by 20 dB from the normal value.

Monitoring Audio

Use the internal speakers or the connected headphones to monitor the audio input to the unit or the audio output from the unit.

Determining the Audio Signal Output Destinations

Select which output destinations to which the audio assigned for each channel fader should be routed. For the output destination, you can select the PGM output connectors, AUX output connectors, or MIX output connectors.

Output from the PGM output connectors

- 1 Press the ACCESS button in the same column of the channel fader to which the audio you want to be the program output is assigned.
- 2 ① In the top menu, select [PGM OUT]; ② select [On], and confirm.

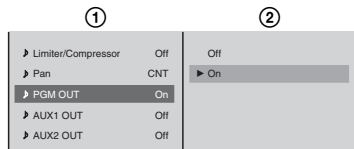

- 3 Press the ESC button to close the ACCESS menu.

Note

You can also close the menu by pressing the same ACCESS button again.

Output from the AUX output connectors

This unit has two sets of AUX output connectors (AUX1, AUX2), and you can create a mix balance with levels different from those of the PGM/MIX output.

- 1 Press the ACCESS button in the same column of the channel fader to which the audio you want to be the AUX output is assigned.
- 2 ① In the top menu, select [AUX1 OUT] or [AUX2 OUT]; ② in the submenu, select [Pre-Fader] or [Post-Fader], and confirm.

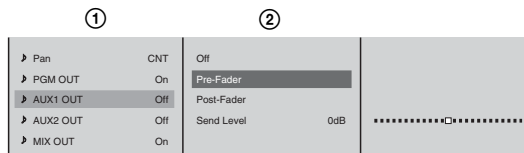

The significance of the items is as follows.

[Pre-Fader]: Output the audio before adjustment by the channel faders. In this case, the audio is output even when the CH ON button is Off.

[Post-Fader]: Output the audio after adjustment by the channel faders.

Note

In either case, when adjusting with the ACCESS menu, the output includes these adjustments (excluding pan).

- 3 After selecting [Pre-Fader] or [Post-Fader] and confirming, ① select [Send Level], and confirm; ② adjust the output level with the slider.

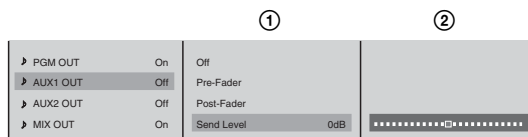

Press the ESC button, to close the ACCESS menu.

Caution

The AUX output connectors output the audio of mixing the left and right audio channels.

Output from the MIX output connectors

- 1 Press the ACCESS button in the same column as the channel fader to which the audio you want to be the MIX output is assigned.
- 2 ① In the top menu, select [MIX OUT]; ② select [On], and confirm.

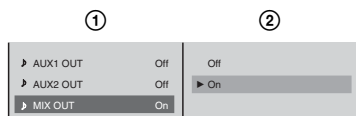

- 3 Press the ESC button to close the ACCESS menu.

Displaying the Audio Signal Output Destinations

Check where the output destinations are set.

- 1 Press the MENU button.
- 2 In the top menu, select [Audio Output].
- 3 Check the output destination display.
The display lights green when set to [ON] in the audio signal output destination settings (page 142).

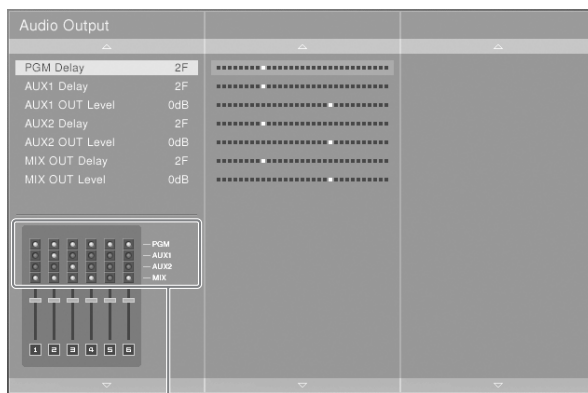

Output destination indication

Monitoring Output Audio

You can select one audio output from this unit (program (PGM) output, AUX output, or MIX output), and listen to it on the internal speakers, speakers connected to the monitor output connectors, or headphones connected to the HEADPHONES connector.

Output sound level can be monitored using the audio level meters on the operation screen.

- 1 Press the MENU button.
- 2 In the top menu, select [Audio Utility].
- 3 ① Select [Audio Monitor], and confirm; ② select the output to be monitored.

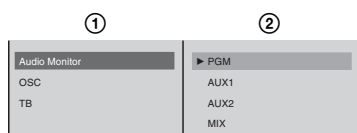

Notes

- Use the monitor level adjustment knob to adjust the level.
- Each time you press the AUDIO MONITOR button, the monitoring cycles through the following sequence. The output destination indication below the audio level meters also changes.

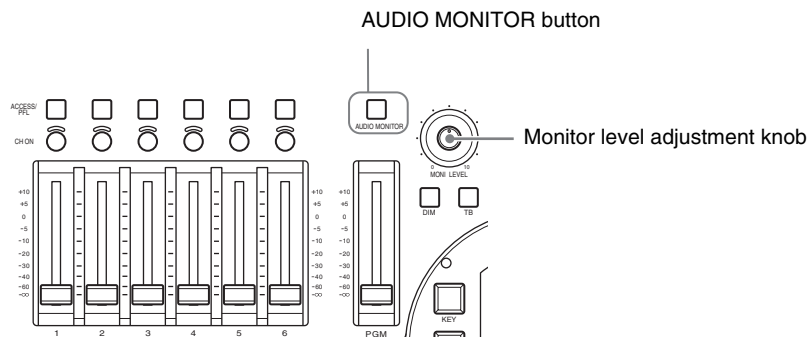

PGM → AUX1 → AUX2 → MIX → PGM ...

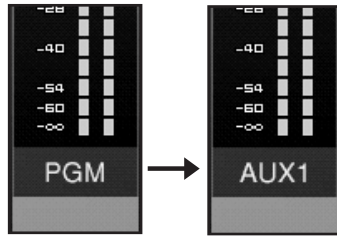

Monitoring the Audio of a Particular Channel Only

Use the Pre-Fader Listening (PFL) function to check the audio on a channel without the channel fader adjustments. You can do this, for example, on the internal speakers.

Hold down the ACCESS button for the channel you want to monitor for at least 0.5 seconds. While the button is held down, the audio for that channel is monitored.

When you release the ACCESS button, the monitoring is ended.

Notes

- If you press another ACCESS button for at least 0.5 second during PFL, the sound of the subsequently specified channel is added.
- This does not affect the program output, AUX output, or MIX output.

Video/Audio Signal Adjustments and Settings

This section describes adjustments to the video and audio signals.

The image quality and sound quality of the inputs to this unit vary depending on factors such as the shooting conditions. This unit therefore has functions to adjust the video and audio of each input to this unit separately.

When using the ACCESS menu to adjust the video input, we recommend outputting the program video to an external monitor and confirming the results as you make adjustments.

Adjusting Analog Video Input Signals

The image quality of an analog video signal input from a composite input or S-video input connector may be adjusted.

- 1 Press the ACCESS button in the same column as the selection button for the video you want to adjust.
- 2 ① In the top menu, select the desired item; ② adjust with the sliders.

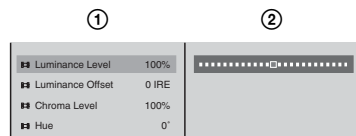

The items you can adjust are as follows.

[Luminance Level]: Adjusts the luminance.

[Luminance Offset]: When inputting video with a 7.5 IRE setting to this unit, select [7.5 IRE].

[Chroma Level]: Adjusts the saturation.

[Hue]: Adjusts the hue.

Note

When applying an offset to the program output video, refer to “Applying an Offset to the Program Output Video” (page 147).

Caution

- The adjustment values given here are for reference only. Actual values may not match these theoretical values during operation.
- When the input signal is in PAL format, moving the jog roller changes the numeric indications and moves the sliders, but the actual value for [Luminance Offset] is fixed at [0 IRE], and the value for [Hue] is fixed at [0°].

- 3 Press the ESC button to close the ACCESS menu.

Note

You can also close the menu by pressing the same ACCESS button again.

Adjusting the Clock Phase of RGB Signals

Of the video signals assigned to the selection buttons, adjust the RGB signals input to the RGB input connectors.
Perform this adjustment to display small characters clearly.

- 1 Press the ACCESS button in the same column as the selection button for the RGB signal you want to adjust.
- 2 ① In the top menu, select [Phase], and confirm; ② adjust with the slider.

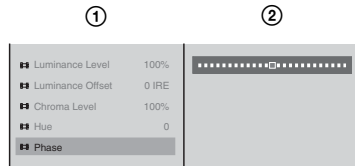

Adjusting Color Matte

Adjust the colors used for color matte, used as single-color backgrounds and so on.

- 1 Press INT in the NEXT selection buttons.
The INT source selection menu appears.
- 2 ① Select the item (displayed under [Color Matte]) to be adjusted, and confirm; ② adjust with the sliders.

As you move the sliders, the sample colors shown in the menu change, so you can check while making the adjustment.

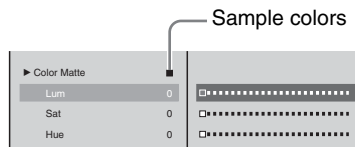

The items you can adjust are as follows.

[Lum]: Adjusts the luminance.

[Sat]: Adjusts the saturation.

[Hue]: Adjusts the hue.

Applying an Offset to the Program Output Video

You can apply a 7.5 IRE offset to the program output video.

- 1 Press the MENU button.
- 2 In the top menu, select [Video Output].
- 3 ① Select [PGM OUT Level], and confirm; ② select [Luminance Offset] from the submenu, and confirm; ③ select [7.5 IRE], and confirm.

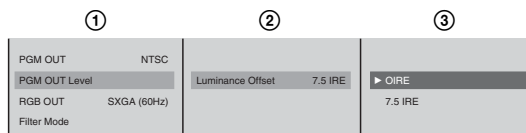

Note

Because there is no offset function for PAL, this setting is only enabled when [PGM OUT] is set to [NTSC].

Setting the RGB Output Signal Format

Set the format of the signal output from the RGB output connectors on the rear panel.

- 1 Press the MENU button.
- 2 In the top menu, select [Video Output].
- 3 ① Select [RGB OUT], and confirm; ② select the combination of image size and frequency or [Video RGB], and confirm.

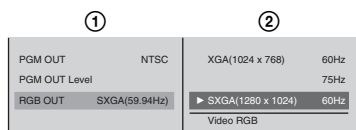

[XGA], [SXGA]: Output format for a computer monitor (computer RGB signals).

[Video RGB]: Output format for a video monitor (video RGB signals).

- 4 Press the MENU button to close the menu.

Caution

- Changing this setting may cause temporary breakup of the output video.
- If the video output signal format is PAL, then when the [XGA] or [SXGA] setting is used, the edge of the image will be missing in the output from the composite video and S video output connectors. This can be remedied by setting [Video RGB], but in this case the computer monitor output will not be available.

Notes

- We recommend that you set this to 60 Hz when the video output signal is NTSC format, and 75 Hz when the signal is PAL format.
- When [Video RGB] is selected, the number of valid scan lines is automatically set to 480 and the frequency to 60 Hz if the output signal format is NTSC, or to 576 lines and 50 Hz when the format is PAL.
- For details of the output signal format, see under video outputs in the Specification (page 190).

- The video image quality for each signal is as follows. Select the best setting for a particular requirement.

Signal name (connector name)	RGB video including fine text and similar	Video including motion
Computer RGB signal (RGB output connector)	Very clear	Depending on the combination, the motion may be slightly jerky*
Video RGB signal (RGB output connector)	Standard video quality (very slightly blurred)	Smooth
Composite/S-Video signal (composite video output connector/S-video output connector)	Standard video quality (somewhat more blurred than the Video RGB signal)	Smooth

* This occurs if the original frame frequency of the shot video and the RGB output frame frequency or signal processing frequency of a plasma display or projector are not in a whole number ratio.

Applying Filters to the Program Output Video

Adjust this setting when the program output video appears blurry or the picture flickers.

- 1 Press the MENU button.
- 2 In the top menu, select [Video Output].
- 3 ① Select [Filter Mode], and confirm; ② select [SD Video] or [RGB] from the submenu, and confirm; ③ select [Soft] or [Sharp], and confirm.

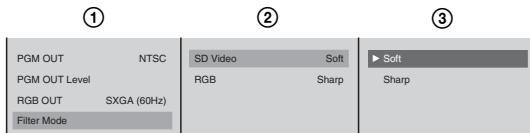

Notes

- Select [Sharp] when the picture is blurry and [Soft] when the picture flickers.
- When [SXGA] is selected for the RGB output signal format setting, since the internal processing size is also SXGA, no filter is required.
- When [Video RGB] is selected for the RGB output signal format setting, the [SD Video] filter settings is applied.

Adjusting the Audio Input Signal Levels

You can adjust individual channels of the audio signals input to this unit.

- 1 Press the ACCESS button for the channel fader to which the audio you want to adjust is assigned.
- 2 ① In the top menu, select [Input Trim]; ② adjust with the sliders.

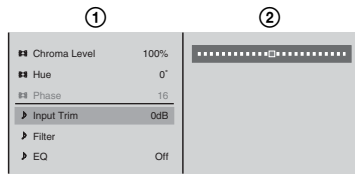

3 Press the ESC button to close the ACCESS menu.

Note

You can also close the menu by pressing the same ACCESS button again.

Cutting High Frequency or Low Frequency

This cuts high frequencies or low frequencies. Use these settings to suppress noise.

Notes

- To cut high frequencies select [High Cut], and to cut low frequencies select [Low Cut].
- You can set both [High Cut] and [Low Cut].

1 Press the ACCESS button in the same column as the channel fader to which the audio you want to adjust is assigned.

2 ① In the top menu, select [Filter]; ② select [High Cut (8kHz)] or [Low Cut (100Hz)].

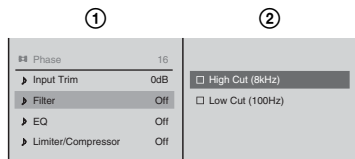

3 Press the ESC button to close the ACCESS menu.

Adjusting the Equalizer

You can adjust the audio quality by using the equalizer to set frequencies in the high, middle, and low audio ranges.

1 Press the ACCESS button in the same column as the channel fader to which the audio you want to adjust is assigned.

2 ① In the top menu, select [EQ]; ② select [On], and confirm.

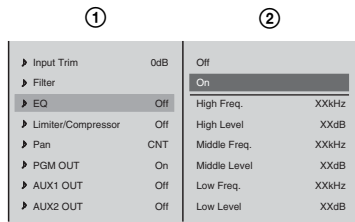

- 3** ① Select an adjustment item from the list, select [On], and confirm; ② adjust with the slider.

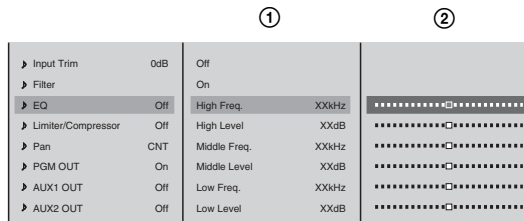

The items you can adjust are as follows.

[High Freq.]: Adjusts the center frequency of the high-frequency band.

[High Level]: Adjusts the level of the high-frequency band.

[Middle Freq.]: Adjusts the center frequency of the middle-frequency band.

[Middle Level]: Adjusts the level of the middle-frequency band.

[Low Freq.]: Adjusts the center frequency of the low-frequency band.

[Low Level]: Adjusts the level of the low-frequency band.

- 4** Press the ESC button to close the ACCESS menu.

Using the Limiter or Compressor

Use the limiter or compressor when inputting audio with large level differences. The limiter restricts the peak components of an audio signal with large level differences. It also compresses the sound exceeding a certain threshold volume so that the threshold level is not exceeded, thus preventing excess outputs. The compressor gently compresses the level of audio at and above the threshold level, thus smoothing out an audio signal with large level differences.

- 1** Press the ACCESS button in the same column as the channel fader to which the audio you want to adjust is assigned.
- 2** ① In the top menu, select [Limiter/Compressor]; ② select [Limiter] or [Compressor], and confirm; ③ with the threshold slider set the level at which the limiter or compressor takes effect.

Note

A gain reduction meter appears to the right of the menu, and shows the current compression.

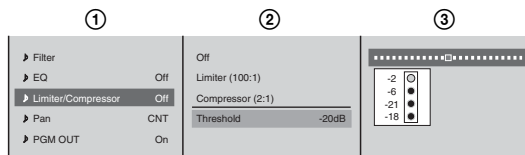

- 3 Press the ESC button to close the ACCESS menu.

Adjusting the Audio Left and Right Channel Balance

- 1 Press the ACCESS button in the same column as the channel fader to which the audio you want to adjust is assigned.
- 2 ① In the top menu, select [Pan]; ② adjust the left and right channel balance with the slider.

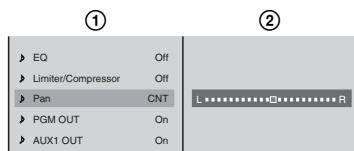

- 3 Press the ESC button to close the ACCESS menu.

Adjusting the Output Levels for Each Destination

Adjust the output audio level for each destination.

- 1 Press the MENU button.
- 2 In the top menu, select [Audio Output].
The [Audio Output] menu appears.

Note

This menu graphically displays the output destination for each channel set in “Determining the Audio Signal Output Destinations” (page 142).

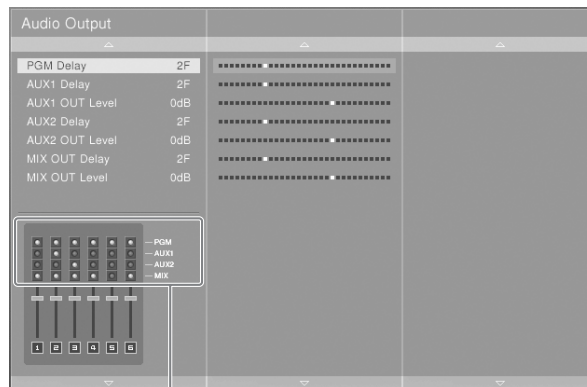

Output destination indication

- 3 ① Select the item you wish to adjust the level, and confirm; ② adjust with the slider.

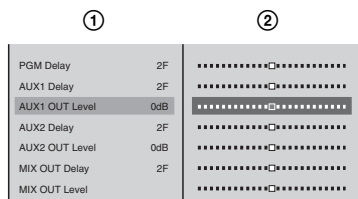

The items for which you can adjust the level are as follows.

[AUX1 OUT Level]: Sets the output level for the audio output from the AUX1 connector.

[AUX2 OUT Level]: Sets the output level for the audio output from the AUX2 connector.

[MIX OUT Level]: Sets the output level for the audio from the MIX output.

Note

Adjust the audio level output from the PGM audio output connectors using the PGM fader on the front panel (page 129).

- 4 Press the MENU button to close the menu.

If the Output Video Is Delayed with Respect to the Audio

If the output video is delayed with respect to the audio, by delaying the audio you can resynchronize it with the video.

- 1 Connect monitor devices to the PGM video output connectors.
- 2 Connect devices to the PGM/AUX/MIX audio output connectors.
- 3 Press the MENU button.
- 4 In the top menu select [Audio Output].
The [Audio Output] menu appears.
- 5 ① Select the item connected to the connector in step 2, and confirm;
② while watching the video connected in step 1, adjust it with the slider.

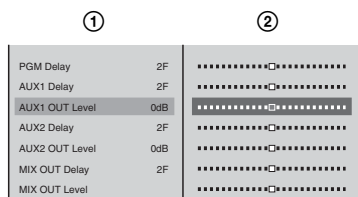

The items for which you can adjust the delay time are as follows.

[PGM Delay]: Sets the delay time for the program output audio in frame units.

[AUX1 Delay]: Sets the delay time for the audio output from the AUX1 connector in frame units.

[AUX2 Delay]: Sets the delay time for the audio output from the AUX2 connector in frame units.

[MIX OUT Delay]: Sets the delay time for the audio from the MIX output in frame units.

Cautions

- Adjusting the delay time may cause noise to occur.
- Video displayed on the PGM viewer lags several frames behind the video output from the PGM video output connectors.

6 Press the MENU button, to close the menu.

Adjusting the Output Using the Oscillator Signal

This is for setting the output oscillator signal for use during adjustment.

- 1** Press the MENU button.
- 2** In the top menu, select [Audio Utility].
- 3** Select [OSC], and confirm, and set the oscillator signal output.

Setting the oscillator signal frequency

① Select [OSC Freq.], and confirm; **②** select the frequency from the submenu, and confirm.

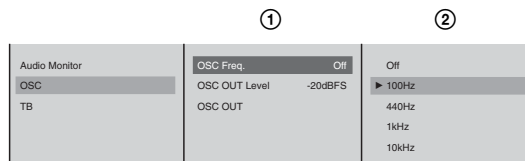

Note

When the output destination is set with [OSC OUT], and a selection other than [Off] is made, the DIM button lights, and the levels of the internal speakers, the headphones, and monitor outputs are automatically reduced.

Setting the oscillator signal output level

① Select [OUT Level], and confirm; **②** adjust the output level with the slider.

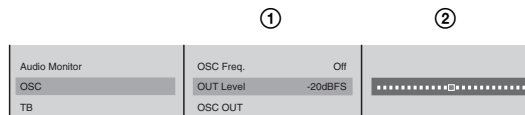

Setting the oscillator signal output destination

① Select [OSC OUT], and confirm; ② select the output destination to output the oscillator signal, and confirm.

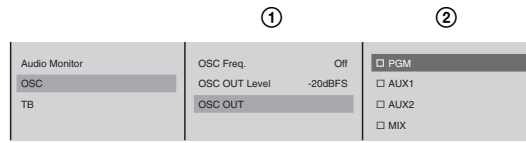

Note

You can select multiple output destination.

- 4 Press the MENU button to close the menu.



Importing and Deleting Files

Using the [File Manager] menu, you can carry out the following file operations.

- Importing graphics files and logo files from a “Memory Stick” or USB flash memory
- Deleting graphics files or logo files imported to this unit
- Deleting files recorded on an external hard disk
- Checking the remaining capacity of the internal hard disk
- Formatting a “Memory Stick,” USB flash memory, or external hard disk

Importable Files

You can import graphics files in the sizes listed below. Depending on the size of a graphics file, it may be resized on import.

Import results by file size for CG and LOGO files

Sizes allowed	Import results
720 × 540 (CG)	Resized to 1280 × 960, and centered vertically
960 × 720 (CG)	Resized to 1280 × 960, and centered vertically
1024 × 768 (CG)	Resized to 1280 × 960, and centered vertically
1280 × 1024 (960) (CG)	Not resized (used as is)
160 × 120 (LOGO)	Not resized (used as is)

Importable file types and extensions

File type	File extension
Targa	.tga .vda .icb .vst
Tiff	.tif .tiff
BMP	.bmp
JPEG	.jpeg .jpg .jpe

Caution

If you create a graphics file with Microsoft PowerPoint for use in downstream keying or luminance keying, save it in BMP format.

Importing Graphics Files

By importing a graphics file to the internal hard disk, you can use it for downstream keying or luminance keying.

- 1 Insert the “Memory Stick” or USB flash memory holding the graphics file in the “Memory Stick” slot or USB connector in the side panel.

Cautions

- Use a “Memory Stick” or USB flash memory that has been formatted using this unit.
- The graphics file must have been placed in the designated folder MSSONY/PRO/LPS/ANYCAST/CG for graphics files.

For details of formatting a “Memory Stick,” see the section, “Formatting a “Memory Stick”” (page 162), and for details of formatting a USB flash memory, see the section, “Formatting a USB Flash Memory” (page 164).

- 2 Press the MENU button.
- 3 In the top menu, select [File Manager].
- 4 ① Select [Import CG File] and confirm; ② Select [Memory Stick], [USB Flash Memory 1], or [USB Flash Memory 2] and confirm; ③ Select the graphics file to be imported and confirm.

The upper USB connector is number 1, and the lower connector is number 2.

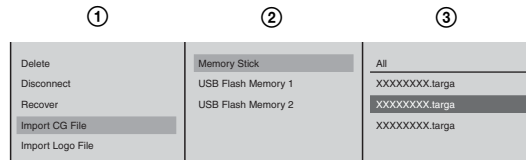

Note

If you select [All] in step ③, all of the files are imported.

Caution

Characters other than alphanumeric characters cannot be displayed correctly.

This imports the graphics file.

When the import is completed, a completion message appears.

- 5 Press the ENTER button.
- 6 Press the MENU button to close the menu.

Note

The imported graphics file can be used in “Using the Downstream Key (DSK) Function to Add Text or an Image” (page 69) or “Using Luminance Keying” (page 74).

Importing Logo Files

By importing a logo file to the internal hard disk, you can display an image (logo) for the purpose of copyright protection.

- 1 Insert the “Memory Stick” or USB flash memory holding the logo file in the “Memory Stick” slot or USB connector in the side panel.

Cautions

- Use a “Memory Stick” or USB flash memory that has been formatted using this unit.
- The logo file must have been placed in the designated folder MSSONY/PRO/LPS/ANYCAST/LOGO for logo files.

For details of formatting a “Memory Stick,” see the section, “Formatting a “Memory Stick”” (page 162), and for details of formatting a USB flash memory, see the section, “Formatting a USB Flash Memory” (page 164).

- 2 Press the MENU button.
- 3 In the top menu, select [File Manager].
- 4
 - ① Select [Import Logo File] and confirm;
 - ② Select [Memory Stick], [USB Flash Memory 1], or [USB Flash Memory 2] and confirm;
 - ③ Select the logo file to be imported and confirm.

The upper USB connector is number 1, and the lower connector is number 2.

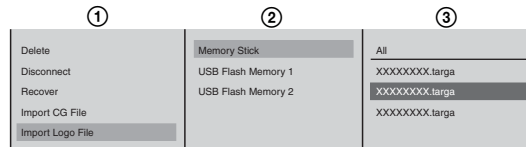

Note

If you select [All] in step ③, all of the files are imported.

Caution

Characters other than alphanumeric characters cannot be displayed correctly.

This imports the logo file.

When the import is completed, a completion message appears.

- 5 Press the ENTER button.
- 6 Press the MENU button to close the menu.

Note

The imported logo file can be used in “Showing a Logo on the Screen” (page 72).

Deleting Files

- 1 Press the MENU button.
- 2 In the top menu, select [File Manager].
- 3
 - ① Select [Delete], and confirm;
 - ② select [CG File], [Logo File] or the hard disk No., and confirm;
 - ③ select the file to be deleted, and confirm.

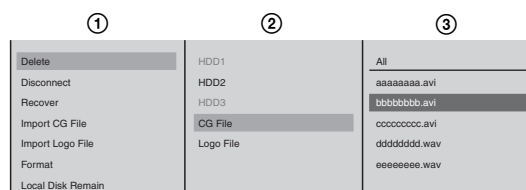

Notes

- It is not possible to delete files on the hard disk that are being used for recording. End the recording before deleting them.
- The file names are arranged in alphabetical order.
- If you select [All] at step ③, all files are deleted.

The following confirmation message appears.

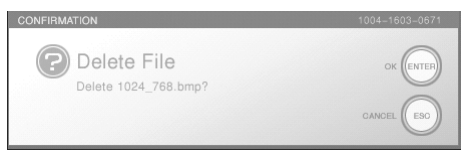

- 4 Press the ENTER button.
This deletes the file.

Caution

While files are being deleted, if you close down the system or start the text typing tool, it will be necessary to recover the hard disk.

- 5 Press the MENU button to close the menu.

Checking the Internal Hard Disk Remaining Capacity

- 1 Press the MENU button.
- 2 In the top menu, select [File Manager].
In the [File Manager] menu, the remaining capacity is shown as [Local Disk Remain].



Formatting an External Hard Disk

Format an external hard disk in order to use it with this unit.
This unit uses the ext3 file system format.

Note

We recommend that you reformat the external hard disk at regular intervals in order to avoid a drop in performance due to file fragmentation.

- 1 Connect the external hard disk to the i.LINK connector (6-pin) of the interface module.

Caution

Be sure to connect the hard disk before powering on this unit.

i.LINK connector (6-pin)

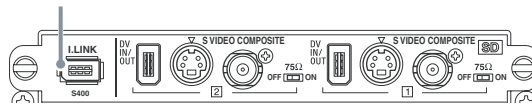

- 2 Power on the hard disk.
- 3 Press the ⏻ (power) button on the side panel, to start up this unit.
The operation screen appears.
- 4 Press the MENU button.
- 5 In the top menu, select [File Manager].
- 6 ① Select [Format] and confirm; ② Select the hard disk number and confirm.

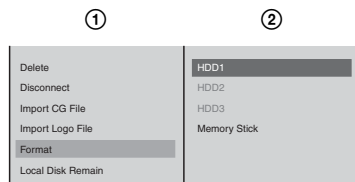

The following message appears.

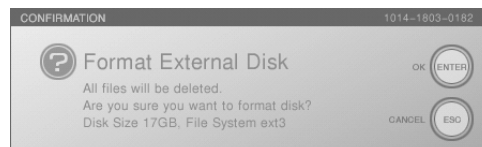

7 Press the ENTER button.

Formatting starts.

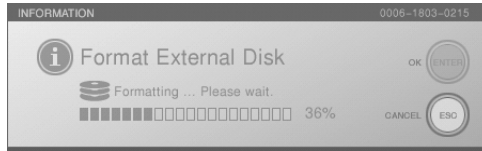

When formatting is completed, the following message appears.

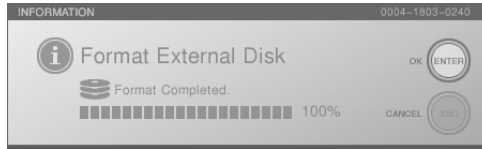

8 Press the ENTER button, to close the message.

9 Press the MENU button, to close the menu.

Formatting a “Memory Stick”

Format a “Memory Stick” so that it can be used with this unit.

In this unit, use the following “Memory Stick” types.

“Memory Stick” type	Use for reading/ writing on this unit
“Memory Stick” “Memory Stick” (with memory select function) “Memory Stick Duo”	Yes
“Memory Stick” (Magicgate/high-speed data transfer support) “Memory Stick Duo” (Magicgate/high-speed data transfer support)	Yes *1*2
Magicgate “Memory Stick” Magicgate “Memory Stick Duo”	Yes *1
“Memory Stick PRO”	Yes *1*2
“Memory Stick PRO Duo”	Yes *1*2

*1 It is not possible to read or write data that requires the Magicgate function.

*2 This unit does not support parallel data transfer (high-speed data transfer).

Cautions

Operation with all types of Memory Stick media is not guaranteed.

- 1 Insert the “Memory Stick” in the “Memory Stick” slot on the side panel.
- 2 Press the MENU button.
- 3 In the top menu, select [File Manager].
- 4 ① Select [Format], and confirm; ② [Memory Stick], and confirm.

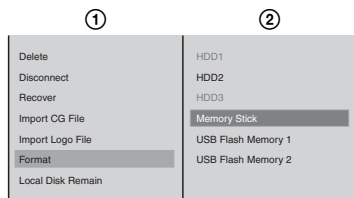

The following message appears.

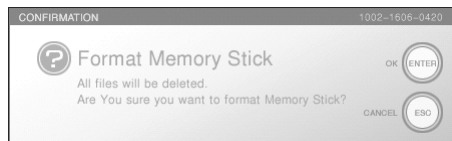

- 5** Press the ENTER button.
The formatting begins.
When the formatting ends, the following message appears.

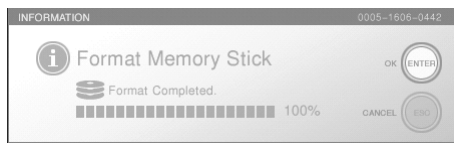

- 6** Press the ENTER button, to close the message.

Note

Formatting a “Memory Stick” on this unit automatically creates the following directory structure on the “Memory Stick”.

MSSONY/PRO/LPS/ANYCAST/INSTALL
 /JOB
 /LICENCE
 /CG
 /LOGO
 /REAL
 /EDL
 /FONT

- 7** Press the MENU button to close the menu.

Formatting a USB Flash Memory

Format a USB flash memory in order to use it with this unit.

- 1 Insert the USB flash memory into the USB connector on the side panel.
The upper USB connector is number 1, and the lower connector is number 2.

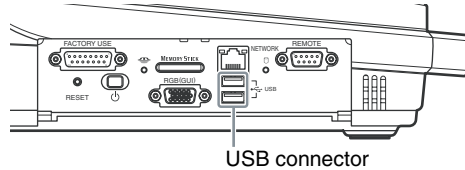

- 2 Press the MENU button.
- 3 In the top menu, select [File Manager].
- 4 ① Select [Format] and confirm; ② Select [USB Flash Memory 1] or [USB Flash Memory 2] and confirm.

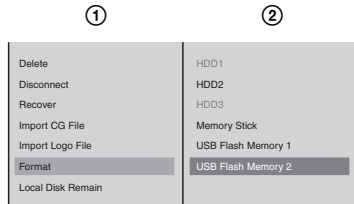

The following confirmation message appears.

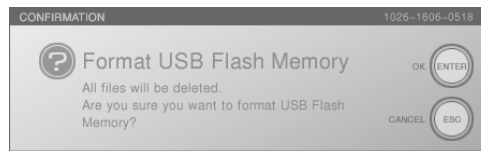

- 5 Press the ENTER button.
Formatting starts.
When formatting is completed, the following message appears.

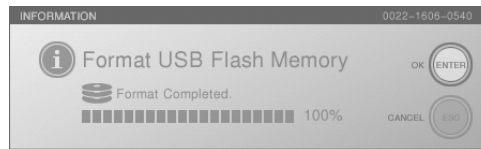

- 6 Press the ENTER button, to close the message.

Note

Formatting USB flash memory on this unit automatically creates the following folder structure in the USB flash memory.

```
MSSONY/PRO/LPS/ANYCAST/INSTALL
                               /JOB
                               /LICENCE
                               /CG
                               /LOGO
                               /REAL
                               /EDL
                               /FONT
```

- 7** Press the MENU button, to close the menu.



Streaming

You can encode the program output into Real Media streaming file format (.rm) within this unit, and broadcast it on the network.

What Is Streaming?

Streaming is one of the transmit multimedia data. Video and audio data is sent across a network, and may be played in real time. To carry out live streaming with this unit, the program video and audio is encoded in the format used by Real Player, and transmitted.

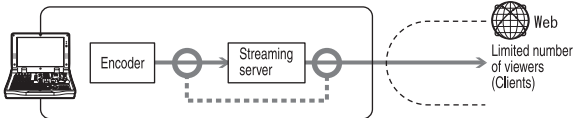
Transmission method	Features
Using this unit as the server	<ul style="list-style-type: none">The results of encoding are sent to the streaming server in the unit, and the viewers access this unit to view the live contents.  <ul style="list-style-type: none">Since viewers directly access this unit, the number of viewing clients and the data transfer rates are limited by the network linking this unit to the viewers.There is no cost for a streaming server.

Caution

You cannot encode the program output into a format other than Real Media streaming file format (.rm). If you want to encode into another format, you need to input the program output of this unit into another encoder and encode it.

Configuring the Network Settings

With the network environment set up, make the network settings for this unit. Ask your network administrator for further information about your network.

- 1 Connect a network cable to the NETWORK connector of this unit.

Caution

In order to meet EMC standards, use an STP (shielded twisted pair) type Ethernet cable.

- 2 Press the MENU button.
- 3 In the top menu, select [Network].
- 4 Set the following items in the submenu.

Entering the host name

① Select [Host Name], and confirm; ② enter the host name in the input box, and confirm.

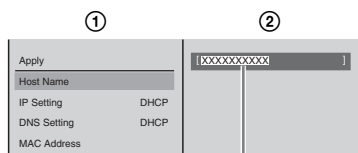

Not more than 15 characters
The first character must be a letter.

Setting the IP address

① Select [IP Setting], and confirm; ② make a selection, and confirm.

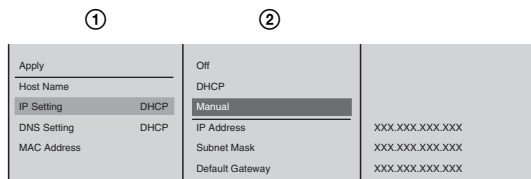

[Off]: if IP address not set

[DHCP]: if address automatically obtained from DHCP server

[Manual]: to input address manually

When [Manual] is selected, enter the following items, and confirm.

Input the default gateway if required.

[IP Address]: Enter the IP address.

[Subnet Mask]: Enter the subnet mask.

[Default Gateway]: Enter the default gateway address.

Caution

Because the unit uses “172.27.72.0 netmask 255.255.255.0” internally, the unit will not operate correctly if settings are configured to include “172.27.72.0 netmask 255.255.255.0”.

Making DNS settings

① Select [DNS Setting], and confirm; ② make a selection, and confirm.

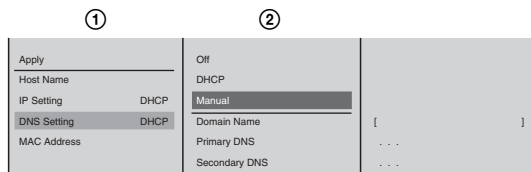

[Off]: if DNS not set

[DHCP]: if address automatically obtained from DHCP server

[Manual]: to input address manually

When [Manual] is selected, enter the following items, and confirm.

[Domain Name]: Enter the domain name. Enter from 3 to 63 alphanumeric characters. The first character must be a letter.

[Primary DNS]: Enter the address of the primary DNS server.

[Secondary DNS]: Enter the address of the secondary DNS server (Enter as required).

- 5 Select [Apply], and confirm.
A network setting update message appears.

Note

If the network settings are not changed, [Apply] is grayed out, and cannot be selected.

Displaying the MAC address

Select [MAC Address] to display the MAC address of the internal network card.

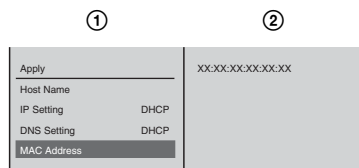

- 6 Press the MENU button to close the menu.

Setting Live Streaming Transmission

Setting the menu

These settings make it possible for the program output from this unit to be encoded in Real Media streaming file format (.rm), and transmitted by live streaming.

- 1 Press the MENU button.
- 2 In the top menu, select [Streaming].
- 3 Set the following items in the submenu.

Selecting live transmission

- ① Select [Output], and confirm;
- ② select [Live], and confirm.

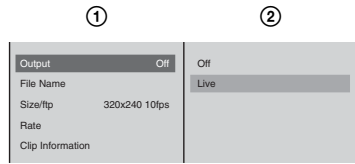

Caution

- When the above operation is done, the PGM viewer on the operation screen becomes smaller.
- Even if left set to [Live], when this unit is powered on again, the setting returns to [Off].



Entering the file name

- ① Select [File Name], and confirm;
- ② enter the file name in the input box, and confirm.

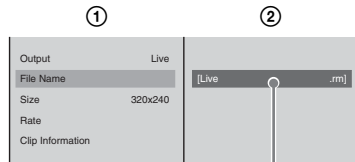

Not more than 20 characters

Setting the video size

① Select [Size], and confirm; ② select the size of video to be output, and confirm.

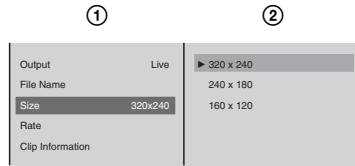

Setting the transfer rate

① Select [Rate], and confirm; ② select [Bit Rate], and confirm; ③ select the transfer rate, and confirm.

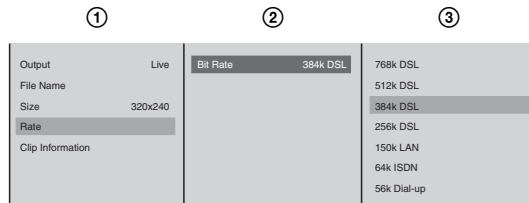

Notes

- The actual transfer rates are as follows.
 - 768k DSL→700 kbps(Video:603.5 kbps Audio:96.5 kbps)
 - 512k DSL→450 kbps(Video:353.5 kbps Audio:96.5 kbps)
 - 384k DSL→350 kbps(Video:285.9 kbps Audio:64.1 kbps)
 - 256k DSL→225 kbps(Video:180.9 kbps Audio:44.1 kbps)
 - 150k LAN→150 kbps(Video:118.0 kbps Audio:32.0 kbps)
 - 64k ISDN→50 kbps(Video:39.0 kbps Audio:11.0 kbps)
 - 56k Dial-up→34 kbps(Video:26.0 kbps Audio:8.0 kbps)
- The following are recommended for combinations of video size and transfer rate:
 - 320 × 240→384k DSL
 - 240 × 180→256k DSL
 - 160 × 120→150k DSL

Entering content information

① Select [Clip Information], and confirm; ② select the item to set, and confirm; ③ enter the information in the input box, and confirm.

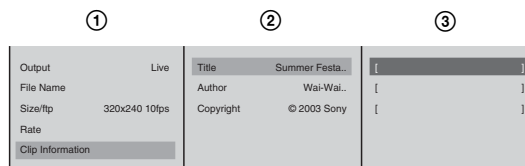

The items you can set are as follows.

[Title]: Enter a title of not more than 50 characters.

[Author]: Enter an author name of not more than 100 characters.

[Copyright]: Enter an owner name of not more than 100 characters.

4 Press the MENU button to close the menu.

Starting and Stopping Streaming

Starting streaming

- 1 Make the settings described in “Configuring the Network Settings” (page 166) and “Setting Live Streaming Transmission” (page 169).
- 2 Press the ON LINE button.
The ON LINE button lights red, and a transmission starts.

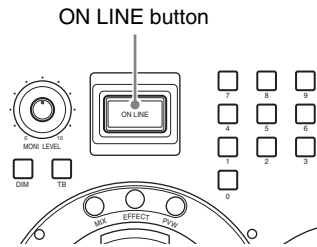

Caution

Be sure to have a client computer available to check that a signal is being transmitted, using Real Player.

Stopping streaming

Hold down the ESC button, and press the ON LINE button.
The ON LINE button goes off, and transmission ends.

Note

It is not possible to stop while the status is shown as “Starting.” Once it shows “Running” you can stop.

Settings Required for Viewing Streaming

This section describes how to configure settings on the computer for viewing material streamed from this unit. Perform these settings on network-ready computers.

Downloading Real Player

Download Real Player from the Web site of RealNetworks, Inc.

Viewing streamed material from the unit

- 1 Start Real Player.
- 2 Click [Open] on the [File] menu.
- 3 Enter the URL of the display area on the unit used for streamed material “rtsp://xxx. xxx. xxx. xxx/broadcast/xxx.rm”.
- 4 Press the Enter key.

Note

Select [Preferences] on the [Tools] menu in Real Player, and configure your connection settings in accordance with your network environment.

Guidelines for number of Real Player connections depending on transfer rate

The following table shows the number of Real Player connections possible for each transfer rate.

The figures are guidelines only, and depend on the operating conditions of the network.

Transfer rate	768k/512k	384k/256k	150k/64k/56k
Number of Real Player connections	5	10	20

When video/audio deteriorates or stops during streaming

Streaming video/audio deteriorates or stops primarily due to network traffic, the player software or settings, or insufficient processing power in the computer running the player software.

If such problems occur, check the above.

When the message “Please wait for a while and reconnect” appears

If you attempt to connect to the unit with Real Player when the server is running (such as when making network settings or when making settings for [Live] in [Output] under [Streaming] on the top menu) but the streaming encoder is not running (the ON LINE button has not been pressed), the standby clip “Please wait for a while and reconnect” appears in the player.

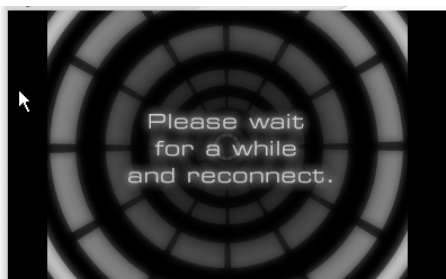

Placing Streaming Links in a Web Site

This section describes how to offer streaming material to viewers using a Web page.

Perform these settings on network-ready computers.

- 1 Open a text editor such as Notepad, and enter the URL for the streaming content in Real Media format as shown below.
`rtsp://IP address of the unit (Helix Server)/broadcast (path)/specified filename.rm`
 Example: `rtsp://xxx.xxx.xxx.xxx/broadcast/live.rm`
- 2 Save the file with the extension “.ram”.

Note

This file becomes the metafile of the Real Media format.

- 3** Upload to the Web server the metafile saved in step 2.
- 4** Insert a link to the metafile in the Web page on which you want to publish the stream.





Maintenance

This section describes how to check the operating software version, and upgrade.

Checking the Operating Software Version

You can check the version number of the operating software and hardware constituting this unit and the interfaces modules installed in this unit, as well as the unit's serial number.

- 1 Press the MENU button.
- 2 In the top menu, select [Version], and then check the displayed version information.

The items you can check are as follows.

Main Application: you can check the version number of the operating software.

Text Typing Tool: You can check the version number of the text typing tool software.

Effect Board: You can check the firmware and hardware version of the effects board.

Audio Board: You can check the firmware and hardware version of the audio board.

Interface Modules 1 to 3: You can check the firmware and hardware version of the rear panel interface modules.

Panel: You can check the firmware version of the front panel.

Serial No. XXXXX

Caution

The interface module version only appears when the module is installed.

- 3 Press the MENU button to close the menu.

Upgrading the Operating Software

This section describes how to upgrade when there are improvements to the operating software and hardware firmware.

Caution

When the external hard disk is connected to the unit, always disconnect it before upgrading the operating software.

Information on upgrades

Information on software upgrades is available from the Anycast Station portal site operated by Sony.

The following site also provides links to the portal site and information on upgrades.

<https://www.ecspert.sony.biz/ecsite/>

<https://servicesplus.us.sony.biz/SoftwarePlusSearch.aspx> (for the customers in the U.S.A.)

<https://www.sonybiz.net/anycast> (for the customers in Europe)

Download to a “Memory Stick” or USB flash memory.

Upgrade procedure

- 1 Insert a “Memory Stick” or USB flash memory holding the installation program in the “Memory Stick” slot or USB connector on the side panel.

Cautions

Before carrying out the following operation, plug the device into the “Memory Stick” slot or USB connector used for installation only, and remove other devices.

- 2 Press the  (power) button on the side panel.
This powers on the unit.

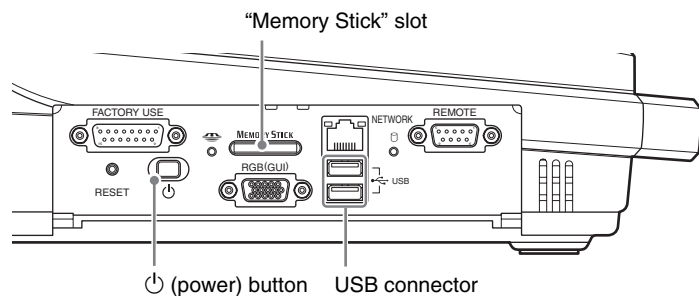

- 3 After the startup screen, press the F10 (Fn+0) key on the keyboard while the message is displayed indicating that function key input is possible.

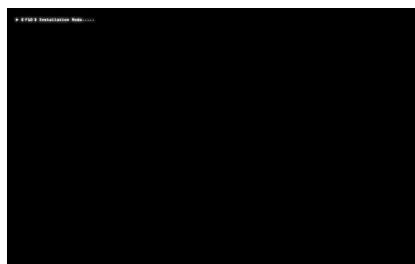

The following screen appears.

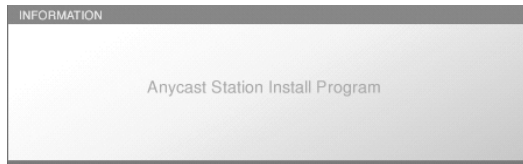

Next the “INSTALL” screen appears, and a message “C: Copying Program files...”

Notes

- If the same version is already installed, this object is grayed out, and excluded from the upgrade.
- The “C:” in “C: Copying Program files...” refers to the “Memory Stick,” and “D:” and “E:” refer respectively to the upper and lower ports to which the USB flash memory is connected.

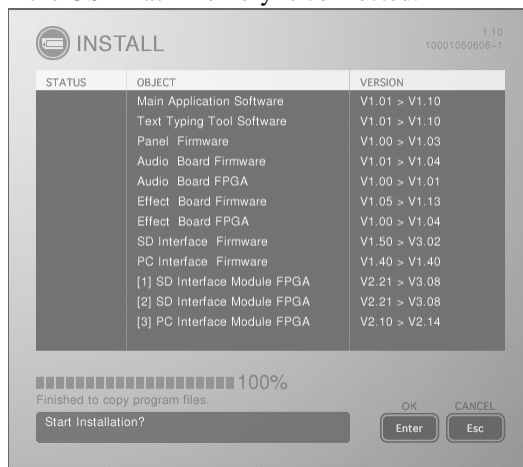

- 4 Check that the progress indication has reached 100%, and press the keyboard ENTER key.

The installation starts.

Installation does not begin if you click the Enter button on the front panel.

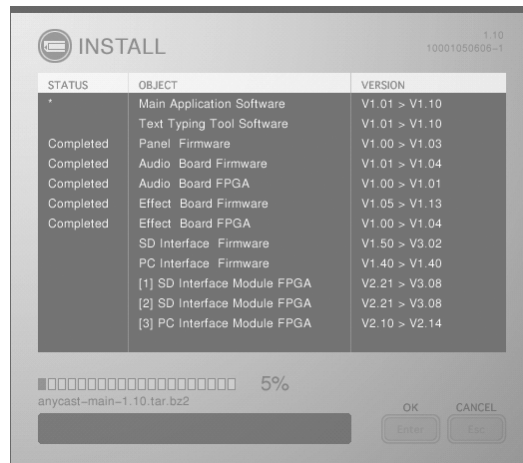

Note

In the “STATUS” column, an asterisk (*) blinks while the operating software is being installed. When installation ends successfully, “Completed” is displayed, and if installation has failed, “Error” is displayed instead.

Caution

Do not turn the unit off or remove a “Memory Stick” or USB flash memory from the unit while data is being read or written; otherwise the file may be destroyed.

When the installation completes, the following message appears.

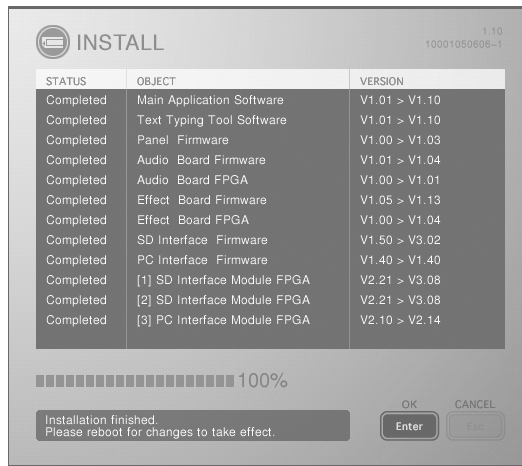

- 5 Check the installation completed message, then press the keyboard ENTER key.

This powers off the unit.

When you next power on the unit, the operating software starts.

Caution

- During the installation, if the “STATUS” indication shows “Error”, repeat the installation process from the beginning. If this does not clear the problem, consult your dealer or your Sony service representative.
- Users who purchased the optional BKAW-550/BKAW-570 should install the optional equipment and then perform the same version upgrade.

Messages

If any problem occurs during operation of this unit, a message appears. Before asking your dealer for help, use the information in this section to try to solve the problem. If this is not successful, make a note of the displayed message number, and consult your dealer or your Sony service representative.

Message Structure

The messages that appear during operation of this unit consist of the following parts.

Anycast Station main software messages

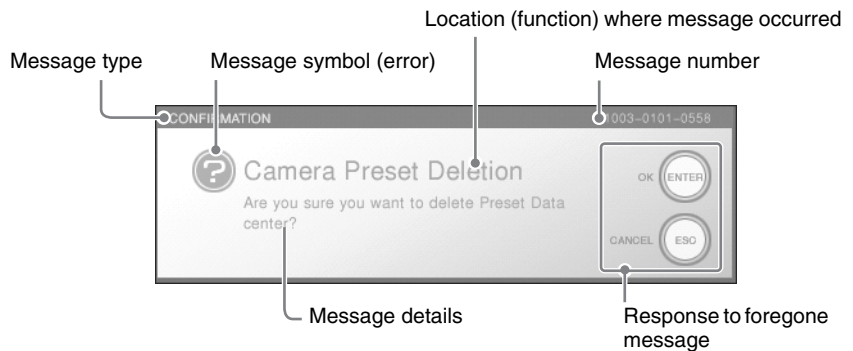

To select [OK], press the ENTER button or Enter key on the keyboard.
To select [Cancel], press the ESC button or Esc key on the keyboard.

Text typing tool software messages

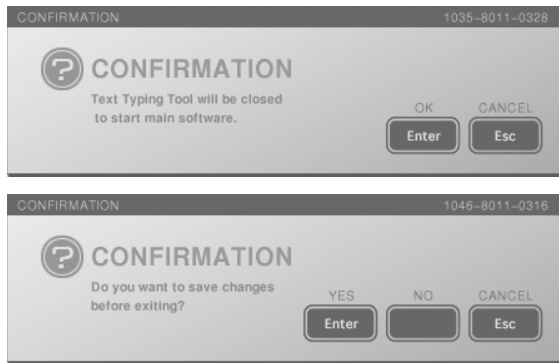

To select [OK] or [YES], click the [Enter], or press the keyboard Enter key.
To select [CANCEL], click the [Esc], or press the keyboard Esc key (Fn+~/ key).
To select [NO], click the [Space].

Message types

The significance of the message type is as follows.

Error message

Message type: ERROR

Message number: 4XXX-YYYY-ZZZZ (begins with 4)

As a result of an operation, an error occurred.

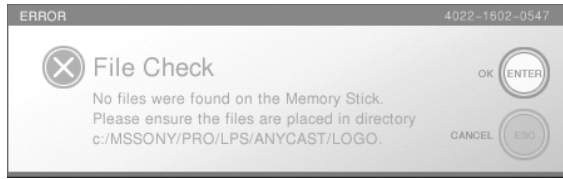

Warning message

message type: WARNING

message number: 2XXX-YYYY-ZZZZ (begins with 2)

This appears when a preliminary check before carrying out an operation discovered a problem.

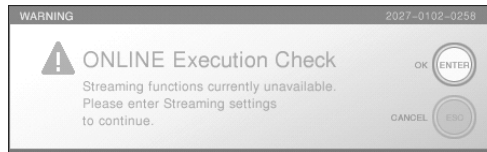

Confirmation message

Message type: CONFIRMATION

Message number: 1XXX-YYYY-ZZZZ (begins with 1)

This type of message requests user confirmation, and can be cancelled.

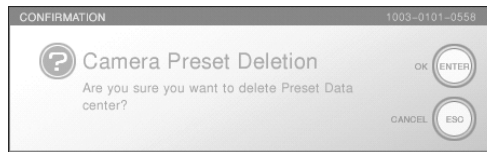

Informational message

Message type: INFORMATION

Message number: 0XXX-YYYY-ZZZZ (begins with 0)

This provides information to the user.

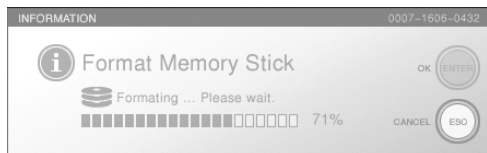

List of Messages

If a message on this list is displayed and still appears after trying the operation again, consult your dealer or your Sony service representative

Number	Message text
0002	Deleting ... Please wait.
0004	Format Completed.
0005	
0006	Formatting ... Please wait.
0007	
0008	Import Complete.
0009	Importing... Please wait.
0010	Shutting Down. Saving System Settings.
0011	Updating Network Settings.
0012	Installation finished. Please reboot for changes to take effect.
0013	Anycast Station Install Program
0014	Checking Memory Device.
0015	"Memory Stick" device was found.
0016	USB Flash Memory device was found.
0017	Installation canceled. Shutting down.
0018	Shutting Down.
0020	The changes will take effect after the next reboot.
0021	It is now safe to remove HDDX.
0022	Format Completed.
0023	Formatting ... Please wait.
0024	To re-mount the HDD, Please ensure it is properly connected and re-start the unit.
0025	Recovery Complete.
0026	Recovering ... Please wait.
0027	Do you want to save changes before exiting?
0028	One font file was copied.
0029	xx font files were copied.
0030	Please wait.
0031	Please wait. Importing... xx/xx fonts.
0032	Please wait.
0033	
0034	Please wait. Exporting... xx/xx sheets.
0035	Please wait.
0036	Please wait. Saving... xx/xx sheets.
0038	One or more frames were dropped during recording. Please check that the recording quality is sufficient.
1002	All files will be deleted. Are you sure you want to format "Memory Stick"?
1003	Are you sure you want to delete Preset Data xx?
1004	Delete xx?
1005	File xx already exists. Overwrite?
1006	File xx is currently being used as the LOGO or INT source. Do you really wish to delete this file?
1007	File xx is currently being used as the LOGO or INT source. Do you really wish to overwrite this file?
1009	Start Installation?
1010	Audio Source also will be set to Analog. L:xx R:xx
1011	When selecting DV Audio, DV Video will be selected automatically.
1012	When selecting DV Video, DV Audio will be selected automatically.
1013	Delete xx? All files on HDDX will be closed.
1014	All files will be deleted. Are you sure you want to format disk? Disk Size xxGB, File System ext3
1015	A file on External HDDX is currently being used. Do you really wish to format the HDD?

Number	Message text
1016	Start recording source X.xxxx.xx.
1017	Slot xx-xx DV interface has already been assigned as an input. Would you like to cancel the assignment and re-assign to the PGM output.
1018	When the audio input assignment is changed, opened files will be closed automatically.
1020	When the PGM Output assignment is changed, any opened files will be closed automatically.
1021	When the video input assignment is changed, opened files will be closed automatically.
1024	Main software will be closed to start Text Typing Tool. Recording and Streaming will be stopped.
1025	A file in External HDDxx is currently being used. Do you really wish to disconnect the HDD?
1026	All files will be deleted. Are you sure you want to format USB Flash Memory?
1027	Are you sure you want to set the Power Off Timer? The system will be shutdown in 2 hours.
1029	Recording of the audio assigned to Source xx is not currently supported. The DV embedded audio will be recorded.
1030	This source has already been assigned to Source No. xx. Would you like to assign it to Source No. xx instead?
1031	Disk recovery may take a considerable time to complete. Do you really wish to run the recovery tool?
1032	Disk recovery may take a considerable time to complete. Do you really wish to run the recovery tool? All files will be closed.
1033	Do you really wish to delete xx?
1034	File Name, Saved Day
1035	Text Typing Tool will be closed to start main software.
1036	<input type="radio"/> Memory Stick <input type="radio"/> USB Flash Memory 1 <input type="radio"/> USB Flash Memory 2
1037	File Name, Saved Day
1038	
1039	<input type="radio"/> All sheets <input type="radio"/> Current sheet
1040	<input type="radio"/> Memory Stick <input type="radio"/> USB Flash Memory 1 <input type="radio"/> USB Flash Memory 2
1041	<input type="radio"/> Duplicate current sheet <input type="radio"/> Create a blank sheet
1042	Do you want to save changes before creating a new file?
1043	Do you want to save changes before opening a new file?
1044	A file with this name already exists. Overwrite?
1045	File Name, Saved Day
1046	Do you want to save changes before exiting?
1047	File Name, Saved Day
2001	Could not find file xx.
2002	Please insert "Memory Stick" or USB flash memory containing Installation Software and select OK to retry installation.
2006	This USB Flash Memory needs formatting by the Anycast Station.
2007	This Memory Stick needs formatting by the Anycast Station.
2009	This type of compressed image file is not supported.
2010	Starting server. Please restart the streaming after a while.
2013	Internal Disk Full.
2014	Invalid Date and Time. YYYY/MM/DD HH:MM
2015	Less than 500MB of free space remaining on Internal Hard Disk.
2016	"Memory Stick" is Write Protected. Please remove Write Protection and re-insert.
2018	Only images of size 160×120 are supported.
2019	Only the following sizes of CG file are supported : 720×540 960×720 1024×768 1280×1024(960).
2020	Please complete the current transiting before pressing the KEY button.

Number	Message text
2021	Please complete the Network Settings before starting streaming.
2022	Please complete the Streaming Settings before starting streaming.
2023	Please complete the Video Output Settings before performing operation.
2024	Please enter Network Settings starting Streaming.
2025	Please insert a USB Flash Memory and select OK to retry.
2026	Source Name contains illegal characters. The characters /,;, *? "< > [] = cannot be used.
2027	Streaming functions currently unavailable. Please enter Streaming settings to continue.
2031	To use the DSK, a CG file must be selected as the INT source. Please select a CG file.
2032	Server busy. Please wait and try again.
2033	Please complete the Date/Time Settings before performing operation.
2035	HDDX has been removed. To avoid file corruption before removing the HDD, please execute "Disconnect" from the File Manager menu.
2036	External Disk HDDX is full.
2037	Cannot record to this disk. The disk is not formatted, or has been formatted with an unrecognized file system.
2038	External Disk HDDX is not recognized.
2039	This file has already been opened. It is not possible to open a file twice.
2041	The number of files on HDDX has exceeded the system limit.
2042	Cannot change the audio input assignment while recording to HDD.
2043	Cannot change the video input assignment while recording to HDD.
2044	Cannot change the PGM Output assignment while recording to HDD.
2047	This USB Flash Memory needs formatting by the Anycast Station.
2049	Please insert a Memory Stick and select OK to retry.
2051	USB Flash Memory is Write Protected. Please remove Write Protection and re-insert.
2052	Problems have been found on HDDX. To avoid errors during HDD recording and playback, please run the recover tool from the File Manager menu.
2053	More than one device is connected to the HDD port (HDDX). Only one HDD can be connected.
2054	Capture function is not ready. Please start main application first.
2055	Internal Disk Full...
2056	Could not create directory xx.
2057	USB Flash Memory full.
2058	Memory Stick full.
2059	This USB Flash Memory is write protected. Please remove Write Protection and re-insert.
2060	This Memory Stick is write protected. Please remove Write Protection and re-insert.
2061	Important System Files Missing.
2062	This USB Flash Memory needs formatting by the Anycast Station.
2063	This Memory Stick needs formatting by the Anycast Station.
2065	Please insert a USB Flash Memory and select OK to retry.
2066	Please insert a Memory Stick and select OK to retry.
2067	There was a invalid Font file, "xx.ttf."
2068	No Font files were found on the USB Flash Memory. Please ensure the Font files are placed in directory. xx:/MSSONY/PRO/LPS/ANYCAST/FONT/
2069	No Font files were found on the Memory Stick. Please ensure the Font files are placed in directory. c:/MSSONY/PRO/LPS/ANYCAST/FONT/
2070	File Name contains illegal characters. The characters ¥ / : ; * ? " < > [] = % cannot be used.
2071	There were invalid Font files, "xx.ttf, xx.ttc, ...".
2072	Recording of this type of source to HDD is not possible.
2073	No files were found on the Memory Stick. Please ensure the files are placed in directory. x:xx

Number	Message text
2074	No files were found on the USB Flash Memory. Please ensure the files are placed in directory.x:xx
2075	Recording of this source to HDD is not possible while DV(SlotX-X) is being used for DV output.
2076	Could not find file xx.
2077	HDDX has been formatted by a later version of Anycast Station, and is incompatible with this version.
2078	More than two storage devices were found. Please ensure only one device is inserted.
4001	An error occurred during formatting.
4002	An error occurred when loading file.
4003	An error occurred when reading file.
4004	An error occurred when writing file.
4005	An error occurred while deleting the file.
4006	An error occurred while exporting.
4007	An error occurred while importing.
4008	An error occurred while opening CG file.
4009	Cannot execute encode process. Please restart the system.
4010	An error occurred while applying Network Settings.
4012	Unable to start due to Hardware Fault.
4013	
4014	
4016	
4017	
4020	
4021	
4022	No files were found on the Memory Stick. Please ensure the files are placed in directory. c:/MSSONY/PRO/LPS/ANYCAST/CG
4023	Unable to start due to Hardware Fault.
4025	
4026	
4027	
4028	
4029	
4030	
4031	
4032	
4033	
4034	
4035	
4036	
4037	
4038	
4039	
4040	
4041	
4042	
4043	
4047	
4048	
4049	Failed to acquire Network Settings from DHCP server. To retry please select "Apply" from the Network Menu.
4050	An error occurred during installation. Retry installation?
4051	Unable to start due to Hardware Fault. Installation Canceled.
4054	Please enter IP Address Settings, then select "Apply".
4055	Please enter Primary DNS Settings, then select "Apply".

Number	Message text
4056	Please enter Subnet Mask Settings, then select "Apply".
4057	The Subnet Mask contains an invalid bit pattern. Please re-enter then select "Apply".
4058	Invalid Default Gateway address. Please re-enter then select "Apply".
4059	When using DHCP to assign DNS Server settings, IP address settings must also be assigned by DHCP. Please re-enter then select "Apply".
4065	Domain Name cannot end with a hyphen or a period. Please re-enter then select "Apply".
4066	Domain Names must be 3 characters or longer. Please re-enter then select "Apply".
4067	Domain Names must start with an alphabetic character. Please re-enter then select "Apply".
4068	Host Names cannot end with a hyphen or a period. Please re-enter then select "Apply".
4069	Unable to start due to Hardware Fault.
4070	External Disk HDDX is full. Recording stopped.
4071	External Disk HDDX is not recognized. Recording stopped.
4074	No files were found on the USB Flash Memory. Please ensure the files are placed in directory. xx:/MSSONY/PRO/LPS/ANYCAST/CG
4075	An error occurred during disconnecting. (HDDX)
4076	An error occurred again. The problem persists. Please contact the service center.
4077	External Disk HDDX is not recognized.
4078	An error occurred during recovering.
4079	More than one device is connected to the HDD port (HDDX). Only one HDD can be connected. Recording Stopped.
4080	An error occurred while deleting xx.
4081	A fault has developed with the internal fan. To avoid damage please shutdown the system as soon as possible.
4082	An error occurred when opening xx.
4083	An error occurred when reading xx.
4084	An error occurred when writing xx.
4085	Memory allocation error.
4086	An error occurred while opening TTF font file xx .
4087	An error occurred while reading file xx. Read permission denied or file does not exist.
4088	An error occurred while Warninging version compatibility of xx.
4089	Opening file failed.
4090	An error occurred while recovering.
4091	Signal format of input source has been changed. Recording stopped.

If the following message appears, immediately turn off the power to the unit and consult your dealer or your Sony service representative.

Number	Message text
4045	A fault has developed with the internal fan.
4046	To avoid damage please shutdown the system as soon as possible.

Troubleshooting

Check this section before consulting your dealer or your Sony service representative. If the unit still does not function properly, consult your dealer or your Sony service representative.

Problem	Possible causes	Possible solutions	See page
Video-related			
Video does not appear in the source viewer.	The connected device is not turned on.	Turn the connected device on.	–
	The cables are not connected properly.	Check that the cables are connected properly.	45
	The input signal is not assigned correctly.	Check that the input signal is assigned correctly.	52
Video does not appear in the PGM viewer.	The FTB button is lit.	Turn off the FTB button.	67
The PGM does not switch.	The [KEY ON] indicator on the operation screen is lit red.	While the KEY button on the front panel is lit green, press the CUT button.	74
Audio-related			
No sound is emitted from the speakers or headphones (the audio level meter does not move).	The connected device is not turned on.	Turn the connected device on.	–
	The cables are not connected properly.	Check that the cables are connected properly.	45
	The input signal is not assigned correctly.	Check that the input signal is assigned correctly.	52
	The CH ON button is not lit.	Turn on the CH ON button.	129
	The audio channel fader has been left turned down.	Turn up the audio channel fader.	129
	The PGM fader has been left turned down.	Turn up the PGM fader.	129
	The monitor destination is set to AUX.	Set the monitor destination displayed below the audio level meter to PGM.	144
No sound is emitted from the speakers or headphones (the audio level meter moves).	The monitor output level is turned down.	Turn up the monitor output level with the monitor level adjustment knob.	129
	The TB button or the DIM button is lit.	Turn off the TB button or the DIM button.	141
No sound is emitted from the internal speakers.	A device is connected to the monitor output connector.		
DV input			
Noise occurs in the video or audio. No video or audio is output.	The signal is not being received clearly.	Disconnect and then reconnect the cables. After reconnecting the cables, restart the connected DV device and the unit.	–



Problem	Possible causes	Possible solutions	See page
Luminance keying and downstream keying			
Keying does not work.	Keying is hidden because of the Crop setting.	Change the Crop setting.	79
	Keying is hidden because of the Clip, Gain, or Density settings.	Change the values set for Clip, Gain, or Density.	71, 78
Keying adjustments do not take effect.	A keying source created with PowerPoint was saved in Tiff format.	Save keying sources created with PowerPoint in BMP format.	156
Luminance keying does not disappear when the KEY button is pressed.	The KEY button is not an On/Off button for luminance keying.	Make the KEY button light green, and perform a transition, such as with the CUT button.	75
Keying does not disappear when the DSK button is pressed.	Luminance keying is being performed.	Make the KEY button light green, and perform a transition, such as with the CUT button.	75
Keying does not disappear when a transition is performed with the KEY button lit.	Downstream keying is being performed.	Turn off the DSK button.	70
Logos			
Keying does not work.	Keying is hidden because of the Clip, Gain, or Density settings.	Change the values set for Clip, Gain, or Density.	73
Camera controls			
The camera cannot be controlled.	The VISCA cables are not connected properly.	Check that the VISCA cables are connected properly (to the VISCA connector on the unit and the VISCA IN connector on the camera).	45
	The camera has not been registered for control.	Register the camera for control.	121
	The NEXT selection button assigned to the video feed from the camera you want to control is not selected.	Select the NEXT selection button assigned to the video feed from the camera you want to control.	123
	The camera status is No Response.	Reset the camera.	127
The camera preset disappears.	The backup switch on the camera (EVI-D100/EVI-D100P) is not set to ON.	Set the backup switch on the camera (EVI-D100/EVI-D100P) to ON before saving the preset.	123

Problem	Possible causes	Possible solutions	See page
Streaming media			
The video message "Please wait for a while and reconnect" appears in Real Player.	The ON LINE button has not been pressed.	Press the ON LINE button.	172
	The file name is wrong.	Check that the file name set on this unit and the file name set in Real Player are the same.	169, 171, 172
The ON LINE button does not turn off.	Only the ON LINE button is pressed.	Hold down the ESC button and press the ON LINE button.	172
The message "Streaming functions currently unavailable. Please enter Streaming settings to continue." appears, the ON LINE button does not be pressed.	The streaming server is not started.	Set for [Live] in [Output] on the top menu under [Streaming].	169
The message "Starting Server. Please restart the streaming after a while." appears, the ON LINE button does not be pressed.	It is a waiting time of the processing that the streaming "status" changes "Initializing" for "Ready". A waiting time depends on the parameters.	Wait several times, or once set for [Off] in [Output] on the top menu under [Streaming], and then set for [Live] again.	169
"The live contents can not be view using Real Player."	The necessary settings for viewing the live contents are not set.	Set the necessary settings for viewing the live contents.	171
	The streaming server does not transmit the live contents on the network.	Once set for [Off] in [Output] on the top menu under [Streaming], and then set for [Live] again.	169
USB device connection			
Cannot enter characters from a USB keyboard, even after disconnecting and reconnecting it.	The USB keyboard was not recognized because it was connected when the computer was busy performing processing for the software.	Try connecting to the other USB connector, or once set for [Off] in [Output] on the top menu under [Streaming]. Or, connect the USB keyboard beforehand when turning on the power.	21, 169
Text typing tool			
Even with [Paint] selected and a transparency set in the [Back Ground] tab, the background is not transparent.	The [Keying] checkbox is not selected.	Select the [Keying] checkbox.	106, 117
Even with [Black] or [White] selected in the [Back Ground] tab, the background is not black or white.	The [Keying] checkbox is selected.	Unselect the [Keying] checkbox.	106, 117
External hard disk			
The hard disk number does not appear in the source viewer.	The source viewer is set to "No Assign."	Set the input with [Video Input Assign] on the top menu.	53
	The source viewer shows "No Interface Module."	Connect the interface module correctly.	51
	The hard disk is not recognized.	Disconnect the cable, then reconnect, and restart this unit.	131, 138
Attempts at recovery yield repeated messages, "An error occurred while recovering."	The hard disk data is unrecoverable.	Use [File Manager] on the top menu → [Format]. * This erases the data.	160

“Memory Stick” Media

Notes on using “Memory Stick” media

- When you set the “Memory Stick” erasure prevention switch to “LOCK”, data cannot be recorded, edited, or deleted.

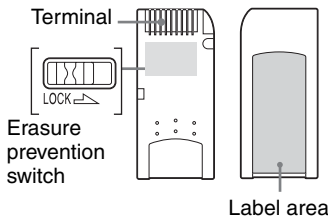

The position and shape of the write-protect switch may differ between the various types of “Memory Stick”.

- Do not remove the “Memory Stick” while it is reading or writing data.
- Data may be damaged if:
 - The “Memory Stick” is removed or the AWS-G500 is turned off while reading or writing.
 - You use the “Memory Stick” in a location subject to the effects of static electricity or electric noise.
- We recommend that you back up important data recorded on the “Memory Stick”.
- Do not affix anything other than the supplied label to the “Memory Stick” label area.
- Affix the label so that it does not stick out beyond the label area.
- When storing or carrying a “Memory Stick”, keep it in its original case.
- Do not touch the terminal of the “Memory Stick” with anything, including your fingers or metallic objects.
- Do not strike, bend, or drop the “Memory Stick”.
- Do not disassemble or modify the “Memory Stick”.
- Do not allow the “Memory Stick” to get wet.
- Do not use or store the “Memory Stick” in locations subject to:
 - Extreme heat, such as in a closed car parked in the sun.
 - Direct sunlight.
 - Humidity or corrosive substances.
 - Formatting is only processed for the

About data

- When you set the “Memory Stick” erasure prevention switch to “LOCK”, data such as images and mails cannot be recorded, edited, or deleted. Be sure to unlock the switch before transferring or copying data on the AWS-G500 to the “Memory Stick”, or erasing data on the “Memory Stick”.
- We recommend that you make a backup copy of important data on another “Memory Stick” or on a hard disk using a computer.

Notes on using “Memory Stick Duo”

- Use a pointed object, such as a ballpoint pen, to move the “Memory Stick Duo” write-protect switch.
- Do not write forcefully on the “Memory Stick Duo” memo area.

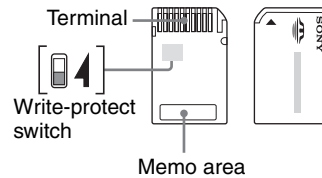

Notes on using the Memory Select function

- You cannot use multiple memory blocks simultaneously or continuously.
- Never operate the Memory Select switch when the “Memory Stick” is inserted in the slot of the AWS-G500, as it may cause damage. Sony Corporation assumes no liability for failure resulting from such operation.
- Make sure that the Memory Select switch is properly positioned to the side. When the switch is not positioned properly, the AWS-G500 may be damaged or malfunction.
- Before inserting the “Memory Stick” in the slot of the AWS-G500, make sure that the memory you want to use is already selected.
- A “Memory Stick” with the Memory Select function allows the user to select the internal memory of the “Memory Stick” with the selector switch. Care must be taken in the following cases as the supported devices only detect the selected memory:
 - selected memory.

- The remaining memory is only indicated for the selected memory.
- Errors are only displayed for the selected memory and are detected separately from the unselected memory.

Specifications

General

Power Requirements
AC 100 V to 240 V, 50/60 Hz

Power Consumption
1.6 A-0.8 A

Operating Temperature
5°C to 40°C (41 to 104°F)

Dimensions (w × h × d)
424 × 114 × 339 mm

Mass
Approximately 17 lb 10 oz
(8.0 kg)

Video Signals

VIDEO INPUTS (standard configuration)

Composite BNC type × 4
Video: 1.0 Vp-p, 75 Ω
Sync negative

S-video DIN type × 4
Y: 1.0 Vp-p, 75 Ω
Sync negative
C: 0.286 Vp-p at burst, 75 Ω
(NTSC)
C: 0.3 Vp-p at burst, 75 Ω
(PAL)

DV IN* i.Link IEEE 1394 6-pin Type × 4
IEC 61883-2 equiv.

RGB D-Sub Shrink 15-pin
Type × 2 (Female)
XGA (1024 × 768, 60 Hz,
75 Hz),
SXGA (1280 × 1024, 75 HZ
60 Hz)
VESA (DMT) compliant

Table of PC RGB Input							
Format		fH	fV	Dot clock	Sync polarity		Stand-ard
		(kHz)	(Hz)	(MHz)	Horiz-ontal	Verti-cal	
1024×768	XGA VESA 60 Hz	48.363	60.004	65	Nega-tive	Nega-tive	VESA (DMT)
	XGA VESA 75 Hz	60.023	75.029	78.75	Posi-tive	Posi-tive	VESA (DMT)
1280×1024	SXGA* VESA 60 Hz	63.981	60.02	108	Posi-tive	Posi-tive	VESA (DMT)
	SXGA* VESA 75 Hz	79.976	75.025	135	Posi-tive	Posi-tive	VESA (DMT)

VIDEO OUTPUTS

Composite BNC type × 1
Video: 1.0 Vp-p, 75 Ω
Sync negative

S-video DIN type × 1
Y: 1.0 Vp-p, 75 Ω
Sync negative

C: 0.286 Vp-p at burst, 75 Ω
(NTSC)
C: 0.3 Vp-p at burst, 75 Ω
(PAL)

DV OUT* i.Link IEEE 1394 6-pin Type \times 4
IEC 61883-2 equiv.

RGB (VIDEO OUT) 15 k RGB (50 Hz/59.94 Hz)
R: 0.7 Vp-p (750)
G: 0.7 Vp-p (750)
B: 0.7 Vp-p (750)
SYNC: Composite sync TTL
output - audio output

RGB D-Sub Shrink 15-pin
Type \times 2 (Female)
XGA (1024 \times 768 60 Hz, 75Hz)
SXGA (1280 \times 1024 60Hz)

Menu setting		Signal format	FH (kHz)	FV (Hz)	Sync
RGB OUT *1	PGM OUT *2				
XGA 60 Hz	-	XGA VESA (DMT) 60 Hz	48.363	60.004	H-negative V-negative
XGA 75 Hz	-	XGA VESA (DMT) 75 Hz	60.023	75.029	H-positive V-positive
SXGA 60 Hz	-	SXGA VESA (DMT) 60 Hz	67.500	75.000	H-positive V-positive
Video RGB	NTSC	15k RGB 60 Hz	15.734	59.940	Composite sync
	PAL	15k RGB 50 Hz	15.625	50.000	Composite sync

*1 For details of RGB OUT settings, see "Setting the RGB Output Signal Format" (page 148).

*2 For details of RGB OUT settings, see "Selecting the Video Output Signal Format" (page 44).

REF OUT BNC Type \times 2
Sync: 0.286 Vp-p, 75 Ω
(NTSC)
Sync: 0.3 Vp-p, 75 Ω
(PAL)
C: 0.286 Vp-p at burst, 75 Ω
(NTSC)
C: 0.3 Vp-p at burst, 75 Ω
(PAL)

Recorder Port

HDD (in exfactory configuration)
i.LINK: IEEE 1394 6-pin
Type \times 2
HDD IF: SBP2

Audio Signals

AUDIO INPUTS

Analog Inputs 1-2
XLR/TRS Combo Type \times 2

Ref. Level:
+4 dBu, -20 dBu, -44 dBu
Mic. Power:
+48 V

Analog Inputs 3-6
TRS Type \times 4 / Ref. Level:
+4 dBu, -20 dBu, -44 dBu

Analog Inputs 7-8
Pin \times 2 / Ref. Level: -10 dBu
DV IN* i.LINK: IEEE 1394 (6 pins) \times 4
IEC 61883-2 compliant
Audio standard level: -20 dBFS
Sampling rate:
12 bit 32 kHz 4ch (uses only
ch 1 and 2)
16 bit 48 kHz 2ch

AUDIO OUTPUTS

PGM OUT TRS Type \times 2 / Ref.: +4 dBu /
Impedance: 150 Ω

MIX OUT Pin Type \times 2 / Ref.: -10 dBu /
Impedance: 470 Ω

AUX OUT TRS Type \times 2 / Ref.: +4 dBu /
Impedance: 150 Ω

MONITOR OUT TRS Type \times 2 / Ref.: +4 dBu /
Impedance: 150 Ω

DV OUT* i.LINK: IEEE 1394 (6 pins) \times 4
IEC 61883-2 compliant
Audio standard level: -20 dBFS
Sampling rate: 16 bit 48 kHz
2ch

HEADPHONES

1/4" Stereo Phone Jack Type \times 1
70 mW \times 2 / Impedance: 47 Ω

INTERCOM

D-Sub 9-pin Type (Female) /
Original Parallel I/O

* DV IN/OUT connectors

Other Interfaces

NETWORK RJ-45 Type \times 1, 10 Base-T/
100 Base-TX

USB USB A type \times 2, USB equiv.

RGB(GUI) D-Sub Shrink 15-pin \times 1
(Female),
WXGA 1280 \times 800 60 Hz

REMOTE

(Provided for future functional expansion.)
D-Sub 9-pin (Male) \times 1,
RS-232C

FACTORY USE

(Provided for future functional expansion.)

D-Sub 15-pin × 1 (Male),

Original Parallel I/O

MEMORY STICK

“Memory Stick” Slot

“Memory Stick Pro” and

“Memory Stick Pro Duo” are

not supported.

VISCA

DIN 8-pin type × 1, RS-232C

Sony VISCA camera

commands are supported.

LCD

15.4” High Brightness LCD,

WXGA (1280 × 800 60 Hz)

Speaker

Built-In Speaker × 2,

Size: 20 × 40 mm

IEC 61883-2 equiv.

HDD

i.LINK: IEEE 1394 6-pin

Type × 1

HDD IF: SBP2

Recommended power cord

NA

Part No. 1-551-812-11

Europe

Part No. 1-782-929-22

Design and specifications are subject to change without notice.

SUPPLIED ACCESSORIES

CD-ROM (× 1)

Notes on using the CD-ROM (× 1)

Pin to BNC connector (× 4)

Battery: CR2032

Operating instruction (× 1)

Keyboard (× 1) 85 keys + Pointer /

Infrared communication

Powered from

AWS-G500: +5 V

Battery operation: CR2032 or

2032 H × 2

OPTIONAL ACCESSORIES

BKAW-550 PC Video Interface Module

(mounted in slot 3 of this unit)

RGB

D-Sub Shrink 15-pin

Type × 2 (Female),

XGA (60 Hz, 75 Hz),

SXGA (60 Hz, 75 Hz)

BKAW-570 SD Video Interface Module

(mounted in slots 1 and 2 of this unit)

Composite

BNC type × 2

Video: 1.0 V_{p-p}, 75 Ω

Sync negative

S-video

DIN type × 2

Y: 1.0 V_{p-p}, 75 Ω

Sync negative

C: 0.286 V_{p-p} at burst, 75 Ω

(NTSC)

C: 0.3 V_{p-p} at burst, 75 Ω

(PAL)

DV IN/OUT

i.LINK: IEEE 1394 6-pin Type

× 2

Dimensions

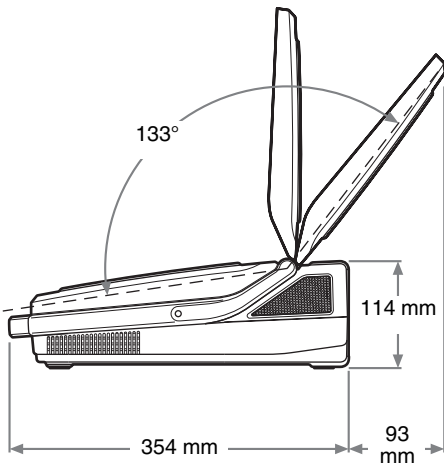
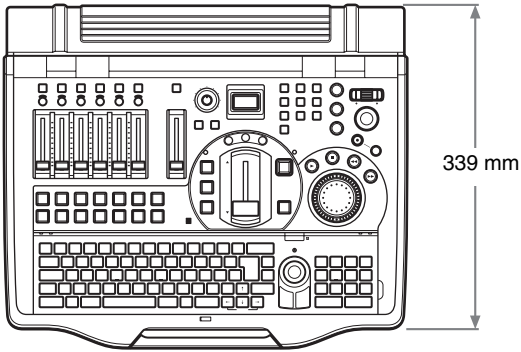
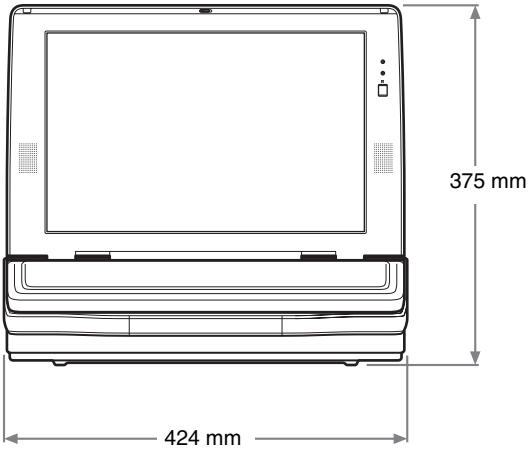

Glossary

Black burst signal

A reference signal used to achieve external synchronization (GenLock).

Color bars

A test signal which displays vertical colored stripes on a monitor. Used to adjust the hue and saturation of colors on video cameras and monitors.

Color matte

A color signal generated by this unit. The hue, saturation, and luminance of color mattes can be adjusted.

Compressor

A function which smoothly limits audio signals exceeding a certain threshold. Used to even out audio signals which contain large differences in amplitude.

Default gateway

A router or computer on a network which serves as an entrance to an outside network. Other computers in the network access the outside network via the default gateway.

Delay

A function which delays audio to bring it into synchronization with video, used when video is input later than the corresponding audio.

DHCP (Dynamic Host Configuration Protocol)

A protocol for automatically assigning IP addresses to clients when they connect to a network, and recovering the addresses when they disconnect.

Dimmer

A function which slightly dims a picture or slightly lowers audio levels.

DNS (Domain Name System)

A system which allows Internet domain names to be translated into IP addresses.

Domain name

An identifier assigned to a group of computers and networks on the Internet. Domain names are delimited by periods (.), and arranged from the left in the order top level domain, second level domain, third level domain, and so forth.

Downstream key (DSK)

A function which allows pictures to be composed by taking video to which an effect has already been applied and adding further images and text. It is called downstream key because this processing is done at the very end of the processing stream.

EMC (Electro-Magnetic Compatibility)

The properties of an electrical device of electromagnetic non-interference and electromagnetic immunity. Electromagnetic non-interference means that when the device operates it does not impair the operation of other devices, and does not act as a source of interference over a certain level that would be harmful to human health. Electromagnetic immunity is the property of electromagnetic susceptibility such that the device can operate without interference from electromagnetic radiation and so forth emitted by other devices.

Encode

To use compression technology to create streaming files with appropriate bitrates for different bandwidths.

Equalizer (EQ)

A function which controls specific audio frequencies in the high, mid, and low regions. Used to strengthen or delete specific frequencies in order to improve the audio.

ext3

A file system widely used with Linux, which adds a journaling function (allowing data changes to be handled as transactions) to the ext2 file system. It requires a shorter time to recover from hardware problems.

Fade to black (FTB)

An effect in which video fades out to a black screen.

Filter

A function which removes high or low frequencies. Used to remove cable noise and other kinds of noise.

Flip

Screen explanatory diagrams, including text, illustrations, graphics, and maps. A flip is displayed in the video and is used to explain the video content.

IEEE1394 (Institute of Electrical and Electronics Engineers 1394)

A standard for a high-speed serial bus for connection not only of computer peripherals, but also of digital devices to each other. Known as FireWire by Apple Computer, and as i.LINK by Sony Corporation.

FTB (Fade to Black)

See Fade to black

GUI (Graphical User Interface)

A user interface which, unlike traditional text-based interfaces, is designed around graphical elements such as buttons and menus.

Intercom

A network that allows staff members to talk to each other during program production.

Host name

A name assigned to a computer on a network to make it easier to identify. Usually consisting of alphanumeric characters, although conventions differ according to the system. The most commonly used types are the terminal identifiers to the left of Internet domain names.

i.LINK

The high-speed serial bus standard IEEE 1394. Also called FireWire. Allows connections between computers and peripherals, and also direct connections between digital devices such as digital cameras.

IPv6

The next-generation Internet Protocol, the successor to the current IPv4 protocol.

IRE (International Radio Engineers)

A measure of the brightness level of video on the grayscale, ranging from 0 to 100. The brightness level of black is sometimes set at 0 IRE and sometimes set at 7.5 IRE.

Limiter

A function which prevents audio levels from exceeding a specified threshold. Used to suppress peaks in audio with large differences in amplitude.

Logo

A permanently visible mark shown in video for the purpose of copyright protection.

Luminance key

A method of composing a picture by deleting video which contains components of a specified luminance (brightness). Typically used to extract bright characters from a dark background, so that only the characters can be added to the composed picture.

Mix

A type of transition effect. A new picture is mixed into an old picture, eventually replacing the old picture.

Monitor

To listen to audio and view video. Or a device for viewing and listening.

Motion JPEG2000

An extension to the JPEG2000 image compression format that enables video recording. It provides picture quality comparable to the DV format, with file sizes that are smaller than DV. It is noted for high compression ratios in scenes with rapid movement, which are problematic for the MPEG format.

Oscillator

A transmitter that oscillates at a fixed frequency, such as a sine wave. This unit is equipped with an internal audio oscillator.

Pan

In audio, to adjust the right/left balance.
In video, to move the camera to the left and right.

PFL (Pre-Fader Listen)

Monitoring audio before level adjustments with the audio channel faders. Used to check the input audio. On this system, pan and level control are not applied to PFL audio, even if trim, filter, EQ, pan, and level control settings have been made.

Post-Fader

Audio signals after the application of all adjustments except pan.

Pre-Fader

Audio signals before the application of any adjustments with audio channel faders. All other adjustments are the same as those for Post-fader. Pre-fader audio can be output from the AUX output connector.

Preset

A function which allows a set of electrical settings to be saved and reproduced as a single set of data. This system has a camera preset function.

Program (PGM) signal output

The final video and audio signals output from this system, after the application of effects. The video seen by viewers.

RCA pin

A connector used on consumer audio equipment. Connectors come in color-coded pairs (often white for left and red for right). Also used for video signals (color yellow).

RGB

An output signal format which displays pictures by using the three primary colors: Red, Green, and Blue.

STP (Shielded Twisted Pair cable)

A type of cable for communications. Copper wires are twisted in pairs, and then shielded.

Streaming

Real-time playback of audio and data received over a network. Compared to “download” playback, which starts after all the data has been received, streaming allows playback of data received up to now. Formats which enable streaming include RealMedia, Windows Media, and Quick Time. This system supports the RealMedia streaming file format (.rm).

Subnet mask

An IP address, which indicates the address of a device in a network, has two components: a network address (the address of the network) and a host address (the address of an individual computer). A subnet mask is a value used to specify how many bits in the IP address are reserved for the network address. A subnet is a smaller network created by dividing a large network into two or more parts.

Superimpose

A type of special effect in video editing, used to display text and pictures over other pictures.

Talk back (TB)

To pass along instructions, for example from a director. In this system, when you talk into the microphone on the front panel, your voice is output to the connected intercom system, allowing you to converse with other people on the intercom system.

TB (Talk Back)

See Talk back.

Telop (Television Opaque Projector)

Superimposed text and image resources, such as television subtitles. This also refers to text and images that have been combined with video.

Threshold

The level at which a limiter or compressor is activated.

Thumbnail

An image which has been reduced in size for the purpose of displaying a list of many images.

Tilt

To move a camera up and down.

Transition

To switch from one video to a different video over a certain time interval. Transitions can be used together with text and image keys to compose and erase pictures.

Transition effect

Gradually switching from one video to another through the application of one of various effects. This systems supports two type of transition effects: mix and wipe.

Trim

To adjust the input level of audio signals. These adjustments are performed at the input stage, before level adjustments with the audio channel faders.

TRS

A jack used in headphones and other devices.

VISCA

A protocol developed by Sony which allows video equipment to be connected to computers.

Wipe

A type of transition effect. A new picture moves in to replace an old picture, as if wiping the old picture away.

XLR

A 3-pin connector, often called a Cannon connector. A locking mechanism keeps the connector securely connected even when the cable is pulled. Very stable despite its simple structure, and often used on microphones to suppress handling noise.



Index

Symbols

- +48V switch 18
- “Memory Stick” slot 21

Numerics

- 75-W termination switch 20

A

- ACCESS buttons 14
- ACCESS menu 27
 - AUX1 OUT 142
 - AUX2 OUT 142
 - Chroma Level 146
 - EQ 150
 - Filter 150
 - Hue 146
 - Input Trim 149
 - Limiter/Compressor ... 151
 - Luminance Level 146
 - Luminance Offset 146
 - MIX OUT 143
 - Pan 152
 - PGM OUT 142
 - Phase 147
- Adjusting Analog Video Input Signals 146
- Adjusting Color Matte 147
- Adjusting the Audio Left and Right Channel Balance .. 152
- Adjusting the equalizer 150
- Adjusting the Output Levels for Each Destination 152
- Adjusting the Program Output Video Image Quality 147
- Analog video input connectors 20
- Audio channel faders 15
- Audio level meter 23
- AUDIO MONITOR button . 15
- Audio Signal Related Settings 54
- AUTO TRANS button . 17, 62
- AUX output connector (AUX) 1/2 (TRS, balanced) 19

B

- BKAW-550 51
- BKAW-570 51

C

- Cable clip 18
- Camera Preset 123
- camera supporting VISCA protocol 121
- CH ON buttons 15
- channel faders 54
- Closing down 40
- Color Bars 68
- Color Mattes 68
- Compressor 151
- Connecting a Camera With VISCA Support 46
- Connecting a Computer 47
- Connecting a Microphone .. 46
- Connecting a Plasma Display/ Projector 49
- Connecting a VCR 48
- Connecting an amplifier 50
- Connections 45
- Controlling Cameras 121
- Cropping 79
- Cut 60
- CUT button 16, 61
- Cut switching 59
- Cutting High Frequency or Low Frequency 150

D

- Deleting Files 158
- Determining the Audio Signal Output Destinations 142
- DIM button 15
- Dimensions 193
- DSK button 16
- DV connectors (DV IN/OUT) 20, 130

E

- Edge 79
- EFFECT button 16, 65, 75
- Effect display 26
- Effect preview 76
- ENTER button 14
- ESC button 14
- Example Applications 13
- External Hard Disk 48, 130

F

- FACTORY USE connector 21
- fade in 68
- fades out 67
- Fade-to-Black 67
- Front Panel 14
- FTB 67
- FTB button 16

G

- Ground terminal 18

H

- Headphone connector (HEADPHONES) (standard phone jack) 19

I

- i.LINK connector (HDD) 20, 130
- Importing Graphics Files .. 156
- Importing Logo Files 157
- Indicators 16
- Input/Output Signals 52
- Installing the Unit 37
- Intercom 140
- Intercom interface connector 18

J

- Jog dial 17
- Jog roller 15

K

KEY button 16
 Keyboard 38

L

Limiter 151
 Line input connectors (LINE)
 7/8 (RCA) 19
 Luminance Keying 74

M

“Memory Stick” 189
 “Memory Stick Duo” 189
 MENU button 15
 Menu operations 28
 Microphone 15
 Microphone/line input
 connectors (MIC/LINE)
 1/2 18
 Microphone/line input
 connectors (MIC/LINE)
 3/4/5/6 18
 MIX button 16, 63
 MIX output connector (MIX)
 L/R (RCA) 19
 Mixing 129
 Monitor level adjustment
 knob 15
 Monitor output connectors
 (MONI) (RCA) 19

N

Names and Functions of
 Parts 14
 NETWORK connector 21
 Network Settings 166
 NEXT selection buttons 16
 Numeric buttons 17

O

ON LINE button 14
 Operating monitor connector
 (RGB (GUI)) 21
 option board 51
 OPTIONAL
 ACCESSORIES 192
 Oscillator Signal 154

Output from the AUX output
 connectors 142
 Output from the MIX output
 connectors 143
 Output from the PGM output
 connectors 142
 output program 59

P

PC video interface module . 51
 PGM audio output connectors
 (PGM) L/R
 (TRS, balanced) 19
 PGM fader 15
 PGM selection button 60
 PGM selection buttons 16
 PGM video output connectors
 (PGM) 19
 PGM viewer 24
 Positioner 17
 power button 21
 Power supply connector
 (~AC IN) 18
 PVW button 16
 PVW viewer 24, 61, 77

R

Real Player 171
 Recording 130
 Reference output connectors
 (REF OUT) 19
 RESET button 21
 RGB input connectors
 (RGB) 20
 RGB Output 148
 RGB output connectors
 (RGB) 19

S

SD video interface module . 51
 Setting the Date and Time .. 42
 Setting the microphone/
 line level 55
 SHIFT button 17
 Showing a Logo on the
 Screen 72
 Shuttle dial 17

Software Version 175
 Source viewer 25
 Specifications 190
 Starting 40
 Streaming 166
 Streaming display 25

SUPPLIED

 ACCESSORIES 192
 Switching a wipe 64
 Switching with a dissolve ... 63

T

TB button 15
 Time 43
 Top menu 27
 Audio Input Assign 54
 Audio MIC/LINE
 Level 56
 Audio Output
 143, 152, 153
 Audio Utility 154
 Date/Time 43
 DSK 70, 71
 DV Output 130
 Fade To Black 68
 File Manager 136, 137,
 157, 158, 159, 160,
 162, 164
 Language 42
 LCD Backlight 43
 Logo 73
 Network 166
 Streaming 169
 Version 175
 Video Effect 67, 79
 Video Input Assign 53
 Video Output
 44, 147, 148
 Transition 62
 transition effect 62
 Transition lever 16, 62
 transition time 66, 70

U

Upgrading the Operating
 Software 176
 USB connector (USB) 21

V



Video Signal Related	
Settings	53
Video Switching	59
Viewing Streamed	
Material	171
VISCA connector	18





Appendix

Trademarks

- Anycast Station and **ANYCAST STATION** are registered trademarks of Sony Corporation.
- “Memory Stick”, , “MagicGate Memory Stick” and **MAGICGATE** are registered trademarks of Sony Corporation.
- “Memory Stick Duo” and **MEMORY STICK DUO** are trademarks of Sony Corporation.
- “MagicGate Memory Stick Duo” is a trademark of Sony Corporation.
- “Memory Stick PRO” and **MEMORY STICK PRO** are trademarks of Sony Corporation.
- “Memory Stick PRO Duo” and **MEMORY STICK PRO DUO** are trademarks of Sony Corporation.
- i.LINK and the iLINK logo “” are trademarks of Sony Corporation.
- All other company names and product names mentioned here may be the trademarks or registered trademarks of their respective companies.
- The symbols for TM and ® are omitted in these instructions.

